



HENNLICH

MERES

# PRŮTOKOMĚR S LOPATKOVÝM KOLEM OMNI-RT

## Flow Transmitter / Switch OMNI-RT



- Universal turbine flow sensor
- Analog output, two switching outputs
- Clear, easily legible, illuminated LCD display
- Modifiable units in the display
- Designed for industrial use
- Small, compact construction
- Simple installation

### Characteristics

A turbine acts as the primary sensor; its rotational speed is proportional to the flow rate. The rotational speed is detected by means of pre-tensioned Hall sensors, i.e. there are no magnets in the flow space.

The OMNI transducer located on the sensor has a backlit graphics LCD display which is very easy to read, both in the dark and in bright sunlight. The graphics display allows the presentation of measured values and parameters in a clearly understandable form. The measured values are displayed to 4 places, together with their physical unit, which may also be modified by the user. The electronics have an analog output (4..20 mA or 0..10 V) and two switching outputs, which can be used as limit switches for monitoring minimal or maximal, or as two-point controllers.

The switching outputs are designed as push-pull drivers, and can therefore be used both as PNP and NPN outputs. Exceeding limit values is signalled by a red LED which is visible over a long distance, and by a cleartext in the display. The stainless steel case has a hardened non-scratch mineral glass pane. It is operated by a programming ring fitted with a magnet, so there is no need to open the operating controls housing, and its leakproofness is permanently ensured.

By turning the ring to right or left, it is simple to modify the parameters (e.g. switching point, hysteresis...). To protect from unintended programming, it can be removed, turned through 180 ° and replaced, or completely removed, thus acting as a key.



### OPTION C:

Preset Counter with external reset option, complementary switching outputs and actual value display.

### OPTION C1:

Instantaneous value display with analogue output, pulse-volume output and totalizer

### Technical data

<b>Sensor</b>	turbine with pre-tensioned Hall sensor	
<b>Nominal width</b>	DN 15..50	
<b>Process connection</b>	Parallel male thread to DIN/ISO 228 Tolerance class B G 1/2 B...G 2 B	
<b>Metering ranges</b>	see table "Ranges"	
<b>Measurement accuracy</b>	±1 % of full scale value in the specified metering range including linearity and repeatability	
<b>Medium temperature</b>	-20..+85 °C optionally -20..+150 °C (for 8 bar min.)	
<b>Ambient temperature</b>	-20..+70 °C	
<b>Storage temperature</b>	-20..+80 °C	
<b>Max. particle size</b>	0.5 mm	
<b>Pressure loss</b>	maximum 0.3 bar at Q <sub>max</sub> .	
<b>Pressure</b>	PN 250 bar	
<b>Materials medium-contact</b>	Housing	stainless steel 316
	Turbine	stainless steel 430
	Bearing	tungsten carbide
<b>Materials Electronic housing</b>	Housing	stainless steel 1.4305
	Glass	mineral glass hardened
	Magnet	samarium-Cobalt
	Ring	POM
<b>Supply voltage</b>	18..30 V DC	
<b>Power consumption</b>	< 1 W	
<b>Analog output</b>	4..20 mA / max. load 500 Ω or 0..10 V / min. load 1 kΩ	
<b>Switching outputs</b>	transistor output "push-pull" (resistant to short circuits and polarity reversal) I <sub>out</sub> = 100 mA max.	
<b>Hysteresis</b>	adjustable, position of the hysteresis depends on minimum or maximum	
<b>Display</b>	backlit graphical LCD-Display (transreflective), extended temperature range -20..+70 °C, 32 x 16 pixels, background illumination, displays value and unit, flashing LED signal lamp with simultaneous message on the display.	
<b>Electrical connection</b>	for round plug connector M12x1, 5-pole	
<b>Ingress protection</b>	IP 67 / (IP 68 when oil-filled)	
<b>Weight</b>	see table "Dimensions"	
<b>Conformity</b>	CE	

# PRŮTOKOMĚŘ S LOPATKOVÝM KOLEM OMNI-RT



HENNLICH

MERES

## Signal output curves

Value x = Begin of the specified range

= not specified range

Current output

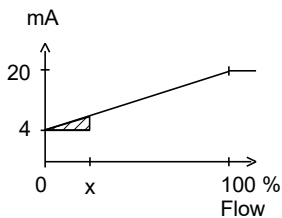

Voltage output

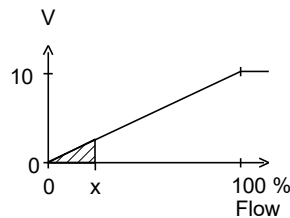

Other characters on request.

## Ranges

Types	Metering range (1..5 mm <sup>2</sup> /s)	
	l/min	m <sup>3</sup> /h
OMNI-RT-015AK001.	1.8.. 18	0.11.. 1.1
OMNI-RT-020AK002.	3.7.. 37	0.22.. 2.2
OMNI-RT-020AK004.	6.7.. 67	0.40.. 4.0
OMNI-RT-020AK008.	13.3.. 133	0.80.. 8.0
OMNI-RT-025AK016.	26.7.. 267	1.60..16.0
OMNI-RT-040AK034.	56.7.. 567	3.40..34.0
OMNI-RT-050AK068.	113.3..1133	6.80..68.0

## Wiring

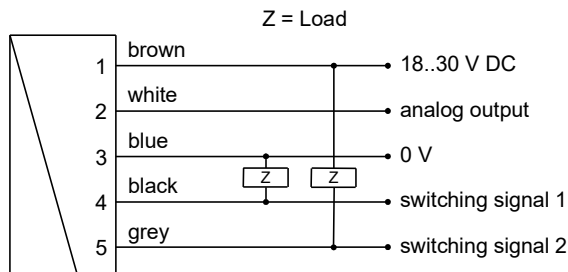

Connection example: PNP NPN

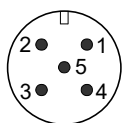

connector M12x1

See separate wiring at C and C1 option in the separate descriptions.

Before the electrical installation, it must be ensured that the supply voltage corresponds to the data sheet.  
The use of shielded cabling is recommended.

## Dimensions

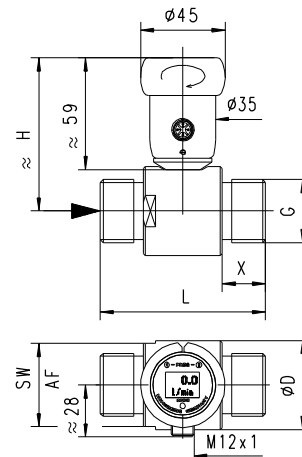

G	DN	Ø D	SW / AF	H	L	X	Range m <sup>3</sup> /h at 1-5 mm <sup>2</sup> /s	Weight kg
G 1/2 <sub>B</sub>	15	38	35	74	64	19	0.11 – 1.1	0.50
G 3/4 <sub>B</sub>	20	38	35	75	64	19	0.22 – 2.2	0.60
G 3/4 <sub>B</sub>	20	38	35	75	64	19	0.40 – 4.0	0.60
G 3/4 <sub>B</sub>	20	40	38	78	83	22	0.80 – 8.0	0.60
G 1 <sub>B</sub>	25	47	44	81	88	23	1.60 – 16.0	0.80
G 1 1/2 <sub>B</sub>	40	60	52	87	114	28	3.40 – 34.0	1.60
G 2 <sub>B</sub>	50	70	64	92	132	29	6.80 – 68.0	2.10

## Gooseneck option



A gooseneck (optional) between the electronics head and the primary sensor provides freedom in the orientation of the sensor. This option simultaneously provides thermal decoupling between the two units.

## Handling and operation

### Installation

As with all flow meters, if possible the turbine should be installed ahead of a valve (on the pressure side). Good degassing should be ensured. 10 X D calming sections are recommended before and after the turbine in order to maintain the specified accuracies. The turbine should be filled with fluid at all times.

It should be ensured that the flow meter and the OMNI electronics are matched to each other.

The electronics housing is permanently connected to the primary sensor, and cannot be removed by the user. After installation, the electronic head can be turned to the best position for reading.

## Programming

The annular gap of the programming ring can be turned to positions 1 and 2. The following actions are possible:



**Set to 1 = continue (STEP)**  
**Set to 2 = modify (PROG)**

**Neutral position between  
1 and 2**

The ring can be removed to act as a key, or turned through 180° and replaced to create a programming protector.

Operation is by dialog with the display messages, which makes its use very simple.

Starting from the normal display (present value and unit), if 1 (STEP) is repeatedly selected, then the display shows the following information in this order:

### Display of the parameters, using position 1

- Switching value S1 (switching point 1 in the selected unit)
- Switching characteristic of S1  
MIN = Monitoring of minimum value  
MAX = Monitoring of maximum value
- Hysteresis 1 (hysteresis value of S1 in the set unit)
- Switching value S2
- Switching characteristic of S2
- Hysteresis 2
- Code  
After entering the **code 111**, further parameters can be defined:
- Filter (settling time of the display and output)
- Physical unit (Units)
- Output: 0..20 mA or 4..20 mA
- 0/4 mA (measured value corresponding to 0/4 mA)
- 20 mA (measured value corresponding to 20 mA)

For models with a voltage output, replace 20 mA accordingly with 10 V.

### Edit, using position 2

If the currently visible parameter is to be modified:

- Turn the annular gap to position 2, so that a flashing cursor appears which displays the position which can be modified.
- By repeatedly turning to position 2, values are increased; by turning to position 1, the cursor moves to the next digit
- Leave the parameter by turning to position 1 (until the cursor leaves the row); this accepts the modification.
- If there is no action within 30 seconds, the device returns to the normal display range without accepting the modification.

The limit switches S1 and S2 can be used to monitor minimal or maximal.

With a minimum-switch, falling below the limit value causes a switchover to the alarm state. Return to the normal state occurs when the limit value plus the set hysteresis is once more exceeded.

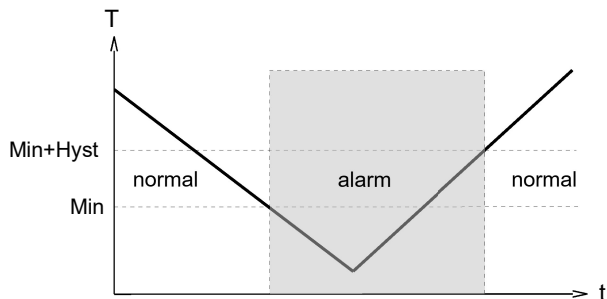

With a maximum-switch, exceeding the limit value causes a switchover to the alarm state. Return to the normal state occurs when the measured value once more falls below the limit value minus the set hysteresis.

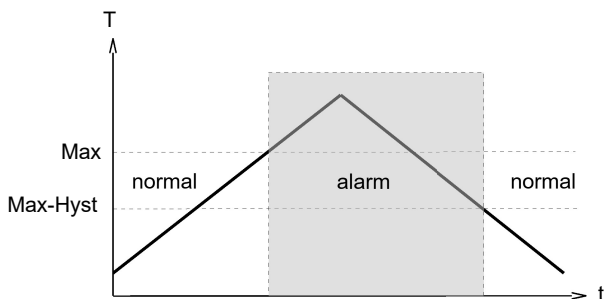

The change to the alarm state is indicated by the integrated red LED and a cleartext in the display.

While in the normal state the switching outputs are at the level of the supply voltage; in the alarm state they are at 0 V, so that a wire break would also display as an alarm state at the signal receiver.

### Overload display

Overload of a switching output is detected and indicated on the display ("Check S 1 / S 2"), and the switching output is switched off.

### Simulation mode

To simplify commissioning, the sensor provides a simulation mode for the analog output. It is possible to create a programmable value in the range 0..26.0 mA at the output (without modifying the process variable). This allows the wiring run between the sensor and the downstream electronics to be tested during commissioning. This mode is accessed by means of **Code 311**.

### Factory settings

After modifying the configuration parameters, it is possible to reset them to the factory settings at any time using **Code 989**.

# PRŮTOKOMĚŘ S LOPATKOVÝM KOLEM OMNI-RT



HENNLICH

MERES

## Ordering code

The basic device is ordered e.g. RT-xxx with electronics e.g. OMNI-RT-xxxx

RT-  1.  2.  3.  4.  5.  6.

OMNI-RT-  7.  8.  9.  10.  11.

○=Option

<b>1. Nominal width</b>									
015	DN 15 - G 1/2 B								
020	DN 20 - G 3/4 B								
025	DN 25 - G 1 B								
040	DN 40 - G 1 1/2 B								
050	DN 50 - G 2 B								
<b>2. Mechanical connection</b>									
A	male thread								
<b>3. Housing material</b>									
K	stainless steel								
<b>4. Metering range</b>									
001	0.11.. 1.1 m³/h								●
002	0.22.. 2.2 m³/h								●
004	0.40.. 4.0 m³/h								●
008	0.80.. 8.0 m³/h								●
016	1.60..16.0 m³/h								●
034	3.40..34.0 m³/h								●
068	6.80..68.0 m³/h								●
<b>5. Connection for</b>									
E	electronics								
<b>6. Option</b>									
H	high temperature model								
<b>7. For nominal width</b>									
015	DN 15 - G 1/2 B								●
020	DN 20 - G 3/4 B								●
025	DN 25 - G 1 B								●
040	DN 40 - G 1 1/2 B								●
050	DN 50 - G 2 B								●
<b>8. Analog output</b>									
I	current output 0/4..20 mA								●
U	voltage output 0/2..10 V								●
K	without								●
<b>9. Electrical connection</b>									
S	for round plug connector M12x1, 5-pole								
<b>10. High temperature</b>									
H	150 °C version								
	tropical model								
O	oil-filled version for heavy duty or outdoor use								
<b>11. Option 2</b>									
C	Counter C								
C1	Counter C1								

## Options

Counter C (hardware and software option):  
Preset Counter with external reset option, complementary switching outputs and actual value display (modified wiring diagram!)

Counter C1 (software option):  
Instantaneous value display with analogue output, pulse-volume output and totalizer

## Accessories

- Cable/round plug connector (K05PU...,KB...) see additional information "Accessories"
- Device configurator ECI-3