

# Retractable rotating cleaning nozzle »PopUp Whirly« Series 5P2/5P3

## Series 5P2/5P3

The PopUp Whirly is designed for cleaning in confined spaces and for tanks or pipelines where conventional cleaning systems could affect the process. The free-spinning rotating nozzle can be installed flush with the wall. When a certain liquid pressure is applied, the rotating cleaning nozzle of the PopUp Whirly extends automatically and starts cleaning. The PopUp Whirly is also suitable for pipe cleaning and for applications that use foam. It is particularly interesting for applications in the food and beverage industry as well as in the chemical and pharmaceutical industry. The ATEX approval makes the PopUp Whirly suitable for use in explosive areas.



	<b>Max. tank diameter [m]</b>	0	1	2	3	4	5	6	7	8	9
--	-------------------------------	---	---	---	---	---	---	---	---	---	---

- Materials**  
316L SS, 316Ti SS, 316 SS, FKM
- Max. temperature**  
140 °C
- Recommended operating pressure**  
2 bar  
5P2: opening pressure approx. 1.0 bar  
closing pressure approx. 0.5 bar  
5P3: opening pressure approx. 0.9 bar  
closing pressure approx. 0.5 bar

**Installation**  
Operation in every direction is possible

**Filtration**  
Line strainer with a mesh size of 0.3 mm/50 mesh

**Bearing**  
Slide bearing

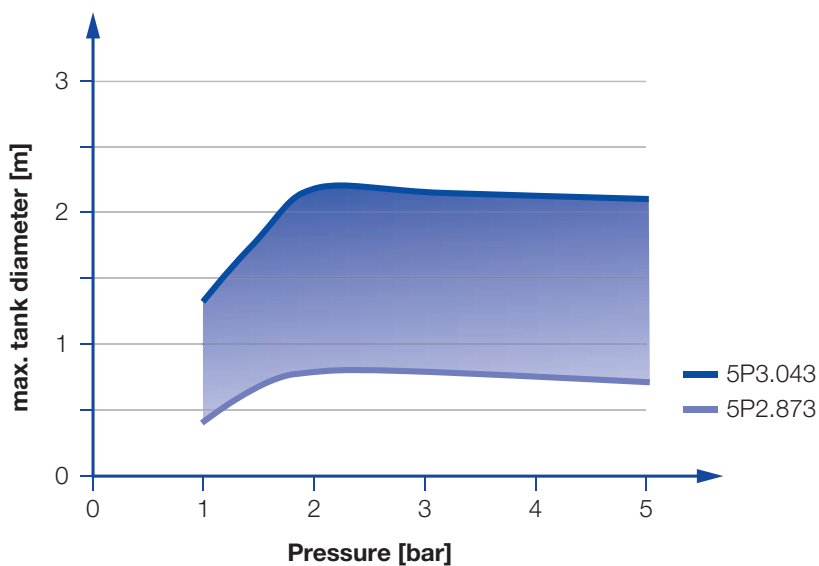

Overview of the tank diameter, depending upon the pressure of series 5P2/5P3

### Series 5P2

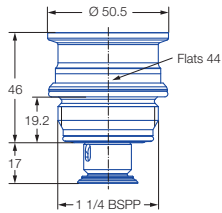

Male thread

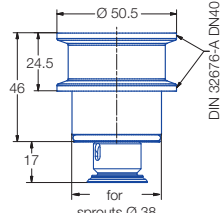

Tri-Clamp

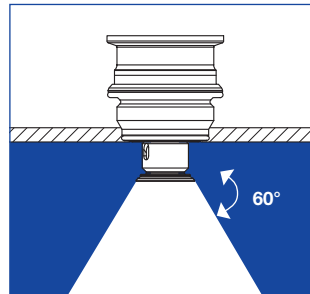

Spray angle	Ordering no.	Tank connection		E Ø [mm]	V̇ [l/min]				Max. tank diameter [m]
		1 1/4 BSPP	Tri-Clamp		p [bar] (p <sub>max</sub> = 6 bar)				
					1	2	3	at 40 psi [US gal/min]	
	<b>5P2.873.1Y.AP</b>	○	-	2.5	10.6	15.0	18.4	5	0.8
	<b>5P2.873.1Y.00</b>	-	○	2.5	10.6	15.0	18.4	5	0.8
	<b>5P2.923.1Y.AP</b>	○	-	3.5	14.1	20.0	24.5	6	1.0
	<b>5P2.923.1Y.00</b>	-	○	3.5	14.1	20.0	24.5	6	1.0

The maximum tank diameter shown above applies for the recommended operating pressure and is indicative only. The cleaning result is also affected by the type of soiling.

### Series 5P3

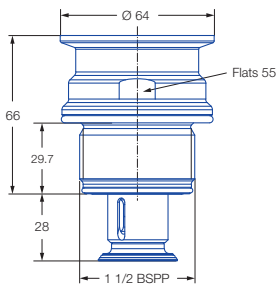

Male thread

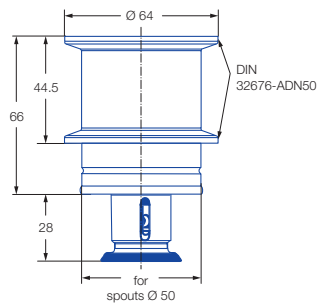

Tri-Clamp

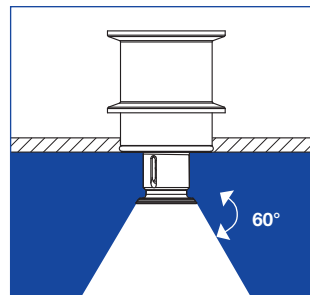

Spray angle	Ordering no.	Tank connection		E Ø [mm]	V̇ [l/min]				Max. tank diameter [m]
		1 1/2 BSPP	Tri-Clamp		p [bar] (p <sub>max</sub> = 6 bar)				
					1	2	3	at 40 psi [US gal/min]	
	<b>5P3.043.1Y.AR</b>	○	-	3.3	28.3	40	49	12	2.2
	<b>5P3.043.1Y.00</b>	-	○	3.3	28.3	40	49	12	2.2

The maximum tank diameter shown above applies for the recommended operating pressure and is indicative only. The cleaning result is also affected by the type of soiling.

### Nozzle installation

With thread

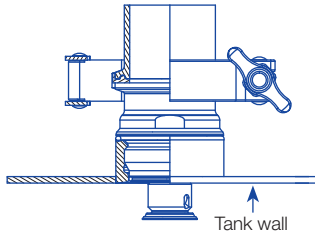

With Tri-Clamp

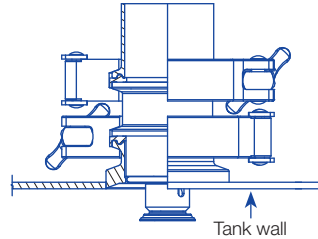

### Information on operation

- The PopUp Whirly is not suitable for operation with compressed air or any other gas.
- Operation above the recommended operating pressure has negative effects on the cleaning result and wear.

### Weld-in flange for Tri-Clamp-Version

5P2

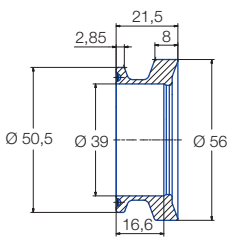

Ord.-no. 050.020.1Y.01.00

5P3

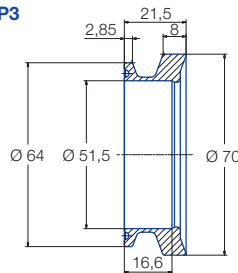

Ord.-no. 050.020.1Y.01.01

### Information

Gasket with a thickness of 2 mm must be used if the PopUp Whirly is installed with this weld-in flange.

### Material

316L SS

### Weld-in socket for Thread-Version

5P2

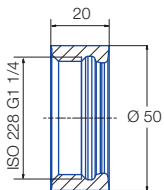

Ord.-no. 050.020.1Y.AQ.00

5P3

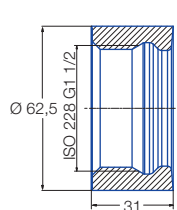

Ord.-no. 050.020.1Y.AS.00

### Information

The thread is hygienically sealed with 2 O-rings included in the scope of delivery.

### Material

316L SS

**Example of ordering with FDA and (EG) 1935/2004 conformity.**

All Materials are suitable for contact with food.



Example of ordering: Type 5P2.873.1Y + Connection AP = Ordering no. 5P2.873.1Y.AP

**Example of ordering with ATEX approval. FDA and (EG) 1935/2004 conform.**

Only material 316L SS available with ATEX approval.

**Unit group / category / zones**

- ⊗ II 1G Ex h IIB T6...T3 Ga
- ⊗ II 1D Ex h IIIC T85 ° C...T170 ° C Da



Example of ordering: Type 5P2.873 + 1Y + Connection AP = Ordering no. 5P2.873.1Y.AP.EX