



E4.1L

The best combination of strength and low weight

Moving energy made even easier - fast harnessing and time-less design



Advantages of the E4.1L system:

- 30% lighter and more cost-effective than the comparable E4.1
- Very cost-efficient: strong and light due to optimised e-chain® link design
- Ideal ratio of internal and external dimensions with thinner outer links and optimised crossbar geometry
- e-chains® and e-tubes openable along the inner and outer radius, from both sides
- Inside completely accessible for easy filling
- Very tightly fitting lids on the e-tubes, virtually no gaps or openings
- Also suitable for side-mounted, standing and hanging applications
- Lower weight, high strength and good dynamics



When to use another e-chain® series:

- For easy, tool-free opening and closing - the next generation of easy-to-assemble e-chains®
 - ▶ E4Q, page 580
- When the e-chain® needs to be extremely quiet (32dB(A)) with very low vibration
 - ▶ E6.1, page 832
- When the e-chain® should have a cleanroom ISO Class 1 classification
 - ▶ E6.1, page 832
- If even higher strength is required
 - ▶ E4.1, page 616



1) Approx. 50% time saving with lean interior separation compared to standard interior separation, tested in the igus® laboratory

2) Approx. 80% time saving with CFU lean strain relief compared to chainfix CFX, tested in the igus® laboratory

3) Approx. 67% less assembly time with E4.48L compared to E4.42, tested in the igus® laboratory

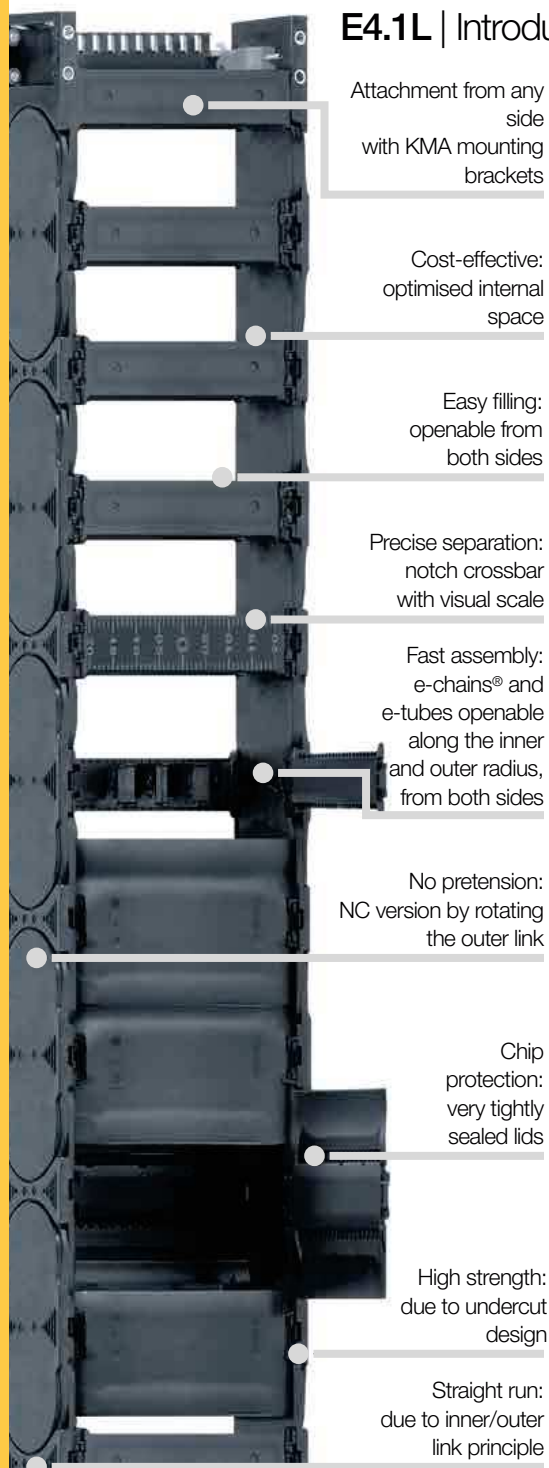

Attachment from any side with KMA mounting brackets

Cost-effective: optimised internal space

Easy filling: openable from both sides

Precise separation: notch crossbar with visual scale

Fast assembly: e-chains® and e-tubes openable along the inner and outer radius, from both sides

No pretension: NC version by rotating the outer link

Chip protection: very tightly sealed lids

High strength: due to undercut design

Straight run: due to inner/outer link principle

The best combination of strength and low weight - E4.1L

Significantly reduce assembly and harnessing time with the E4.1L(ean). Whether as an e-chain® or a chip-proof energy tube, with its sleek design and matching accessories the E4.1L brings maximum efficiency at a cost-effective price. An easily accessible interior, improved crossbars and separators and the new honeycomb strain relief system result in an 80% faster installation. Easily adaptable to any application due to the modular design, this universal solution makes optimal use of the space, is lighter than the alternatives and yet extremely strong. A cable-friendly interior ensures a long service life for the cables. The E4.1L reduces downtime and the assembly and maintenance time whilst saving time and money in operation and acquisition.

Typical industries and applications

- Machine tools
- General mechanical engineering
- If the strength of the E2/000 is insufficient, but an E4.1 is oversized



Electrically conductive ESD e-chains® upon request



High torsional rigidity



iF product design award 2014 for series R4.1L

2014

Series	Inner height <i>hi</i> [mm]	Inner width <i>Bi</i> [mm]	Outer width <i>Ba</i> [mm]	Outer height <i>ha</i> [mm]	Bend radius <i>R</i> [mm]	Unsupported length ≤ [m]	Page
--------	--------------------------------	-------------------------------	-------------------------------	--------------------------------	------------------------------	--------------------------	------



e-chains® with crossbars every link
the lightweight all-rounder - even for demanding applications
Please observe the guidelines for the e-chains® selection, further information ► From page 114

E4.31L	311	40 - 175	54 - 189	42	055 - 250	2.00	548
E4.38L	38	50 - 300	66 - 316	54	063 - 300	2.75	554
E4.48L	48	50 - 300	70 - 320	64	075 - 350	3.75	562
E4.64L	64	75 - 350	101 - 376	84	100 - 400	4.00	572



e-tubes
lightweight, fully enclosed, excellent cable protection
Please observe the guidelines for the e-chains® selection, further information ► From page 114

R4.31L	31	50 - 100	64 - 114	42	075 - 250	2.00	548
R4.38L	38	50 - 250	66 - 266	54	125 - 300	2.75	554
R4.48L	48	50 - 250	70 - 270	64	125 - 350	3.75	562



Available from stock. Ready to ship in 24 - 48hrs.*

*Average time before the ordered goods are dispatched.



What does "Lean" mean in the E4.1L system?

Making a system "lean" means that its individual components are ideally matched to each other, making it more optimised. The aim is to avoid waste and increase efficiency. This is achieved in two ways: from the customer's point of view in order to fulfil their requirements, and from the producer's point of view in order to improve productivity and efficiency. igus® implements these lean properties in its energy supply systems in order to make time-saving e-chain® assembly possible, while also enabling quick and easy harnessing with cables.



E4.1L e-chains® and R4.1L e-tube crossbars, lids and shelves are openable along the inner and outer radius, from both sides



Lean separators enable extremely fast cable filling in several layers



Assembled in seconds - CFU honeycomb strain relief. Simply insert cables and hoses into the honeycomb and close

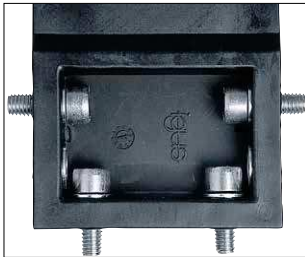

KMA mounting brackets with attachment options from any side



Safe parallel guiding of corrugated tubes with the optional, external TUB guidance



Extension links - for extremely wide e-chains® up to 2.0m with 50% more fill weight

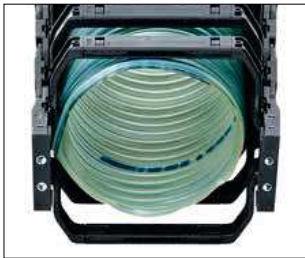

Flexible extender crossbar range - e-chain® extender with crossbars for enlarging the interior



Aluminium "SuperTrough" - the standard igus® guide trough ▶ **From page 1298**



Aluminium and steel support tray for support of the lower run ▶ **From page 1362**

Technical data

	Speed gliding ¹⁾ / acceleration gliding ¹⁾	≤ 5 [m/s] / ≤ 25 [m/s ²]
	Speed FL_G / acceleration FL_G	≤ 20 [m/s] / ≤ 200 [m/s ²]
	Speed FL_B / acceleration FL_B	≤ 3 [m/s] / ≤ 6 [m/s ²]
	Material - permitted temperature °C, igumid G	-40°C / +120°C
	Flammability class, igumid G	VDE 0304 IIC UL94-HB

FL_G = unsupported with straight upper run FL_B = unsupported with permitted sag

¹⁾ Series E4.31L / R4.31L: If a gliding application is required for a long travel, please consult igus®.

Installation types, maximum travels

Series	Unsupported	Gliding ¹⁾	Vertical hanging	Vertical standing	Side mounted unsupported
E4.31L / R4.31L	≤ 4.0m	upon request	≤ 40m	≤ 2.5m	≤ 0.6m
E4.38L / R4.38L	≤ 5.5m	≤ 80m	≤ 50m	≤ 3.0m	≤ 1.0m
E4.48L / R4.48L	≤ 7.5m	≤ 100m	≤ 80m	≤ 3.0m	≤ 1.2m
E4.64L	≤ 4.0m	upon request	≤ 80m	≤ 8.0m	≤ 2.0m

¹⁾ Series E4.31L / R4.31L: If a gliding application is required for a long travel, please consult igus®.



Swarf test in the igus® lab - protection demonstrated in this test setup; stop-dogs completely free of swarf



The light and fully enclosed R4.1 L e-tubes from igus® are now available in a high-temperature version

Interior separation

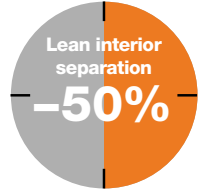

Approx. 50% time saving with lean interior separation compared to standard interior separation*



Lean interior separation vs. standard interior separation - time saving due to easy shelf fitting

Time-saving lean separators

- The design of the igus® lean separators allows extremely fast fitting of shelves in several layers
- Enable extremely fast replacement of individual cables in a very full e-chain®
- Several layers of cables fitted quickly
- Save up to 50%* assembly time

*Lean interior separation vs. standard interior separation. Measured on a 4m long e-chain® fitted with 12 cables in the igus® lab

▶ **approx. 50% time saving**

Strain relief

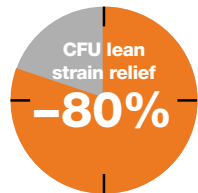

Approx. 80% time saving with CFU strain relief compared to conventional chainfix CFX clamps*



Lean strain relief CFU vs. chainfix CFX - time-saving due to the innovative honeycomb structure

CFU.V strain relief with innovative honeycomb design for fast assembly and high holding force

- 80%* faster filling, openable from both sides for assembly in seconds
- Flexible honeycomb design for increased holding force
- Tribologically optimised honeycomb design for the best hold
- Different cables with diameters from 2mm to 17mm can be strain-relieved without problems
- Cables can be replaced easily
- Easy positioning of cables

*Lean strain relief CFU vs. chainfix CFX. Measured on a 4m long e-chain® fitted with 12 cables in the igus® lab

▶ **approx. 80% time saving**

Opening crossbars and lids

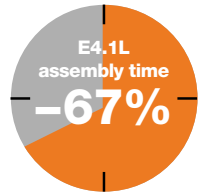

Approx. 67% less assembly time with E4.1L compared to E4.1*



Serie E4.48L vs. E4.42 - time-saving due to easy opening mechanism







E4.1L - fast to harness

- With one of igus® fastest opening systems for simple e-chains® harnessing
- Save up to 67%* assembly time
- Lower weight, cable-friendly interior and improved ratio of inner to outer size
- Easy accessibility of the complete inner space, openable from both sides

*Series E4.48L vs. E4.42. Assembly time tested at the igus® lab

▶ **approx. 67% time saving**

Options with order keys | Examples based on series E4.38L/R4.38L

 Standard	Simply turn outer side link, no additional rework	Reverse Bend Radius (RBR) for circular movements	Unsupported lengths +25% possible
Part No. Standard	Part No. NC version	Part No. RBR	Part No. XXL material
			
 E4.38L.100.R.0 e-chain® with crossbars every link	E4.38L.100.R.0.NC e-chain® with crossbars every link	E4.38L.100.R1/R2.0 e-chain® with crossbars every link	E4.38L.100.R.0.XXL e-chain® with crossbars every link ¹⁾
R4.38L.100.R.0 e-tube, closed	R4.38L.100.R.0.NC e-tube, closed	RBR for e-tubes - please consult igus®	R4.38L.100.R.0.XXL e-tube, closed ¹⁾
 Ready to ship in 24 - 48hrs.*	Ready to ship in 24 - 48hrs.*	Ready to ship in 12 business days*	Ready to ship in 12 business days*

ESD - electrically conductive material

Part No. igumid ESD

E4.38L.100.R.0.ESD e-chain® with crossbars every link
R4.38L.100.R.0.ESD e-tube, closed
Ready to ship in 12 business days*

Order example | Examples based on series E4.38L

 **Order example for complete e-chain® (1.0m), colour black, with mounting brackets and interior separation:**

e-chain® (1.0m)	Please indicate e-chain® length or number of links: 1.0m or 18 links	E4.38L.100.150.0
+ Mounting brackets	1 set (with odd number of links and integrated C-profiles)	E4.380.100.1.12.C
Interior separation	with 2 separators assembled every 2 nd link	2 x 38.1.1
Order text:	1m E4.38L.100.150.0 + E4.380.100.1.12.C + 2 x 38.1.1	

Order key and colour examples | Examples based on series E4.38L/R4.38L

 **Order key**

e-chain® with crossbars every link **E4.38L.100.150.0**

e-tube fully enclosed **R4.38L.100.150.0**

Series / Type 







Inner height 

Width index (depends on B) 

Bend radius *R* 

Colour index (standard black) 

Order index for colour options

Colour	Order index	Colour	Order index
 Black	Standard .0	 Orange	Special colour .2
 Silver-grey	Special colour .31	 Yellow	Special colour .4
 White	Special colour .1	 Light grey	Special colour .14
 Grey-white	Special colour .1S		

Black e-chains® ready to ship in 24 - 48hrs.*

Above special colours upon request.



e-chains® | E4.31L | Crossbars every link (openable along inner and outer radius, from both sides)
 e-tubes | R4.31L | Fully enclosed (lids openable along inner and outer radius, from both sides)

Part No.	Part No.	Bi	Ba	E4.31L	R4.31L	Part No.	Part No.	Bi	Ba	E4.31L	R4.31L
e-chains®	e-tubes	[mm]	[mm]	[kg/m]	[kg/m]	e-chains®	e-tubes	[mm]	[mm]	[kg/m]	[kg/m]
E4.31L.040.R.0	-	40	54	≈ 0.70	-	E4.31L.125.R.0	R4.31L.125.R.0**	125	139	≈ 0.96	≈ 1.28
E4.31L.050.R.0	R4.31L.050.R.0	50	64	≈ 0.74	≈ 0.87	E4.31L.137.R.0**	-	137	151	≈ 0.98	-
E4.31L.062.R.0	-	62	76	≈ 0.76	-	E4.31L.150.R.0	R4.31L.150.R.0**	150	164	≈ 1.00	≈ 1.40
E4.31L.075.R.0	R4.31L.075.R.0	75	89	≈ 0.78	≈ 1.01	E4.31L.162.R.0	-	162	176	≈ 1.04	-
E4.31L.087.R.0	-	87	101	≈ 0.83	-	E4.31L.175.R.0	R4.31L.175.R.0**	175	189	≈ 1.13	≈ 1.55
E4.31L.100.R.0	R4.31L.100.R.0	100	114	≈ 0.88	≈ 1.10	E4.31L.187.R.0**	-	187	201	≈ 1.17	-
E4.31L.112.R.0	-	112	126	≈ 0.93	-	E4.31L.200.R.0**	R4.31L.200.R.0**	200	214	≈ 1.17	≈ 1.68

**Width available upon request. Please consult igus® for delivery time.

1) Radius not available for e-tubes

Available bend radii

R [mm] | 055¹⁾ | 063¹⁾ | 075 | 100 | 125 | 150 | 175 | 200 | 250 |

Complete Part No. with required radius (R). Example:

E4.31L.050.075.0 = crossbars every link / R4.31L.050.075.0 = fully enclosed

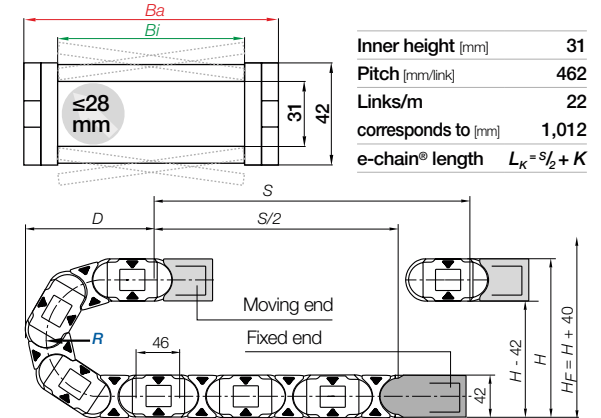
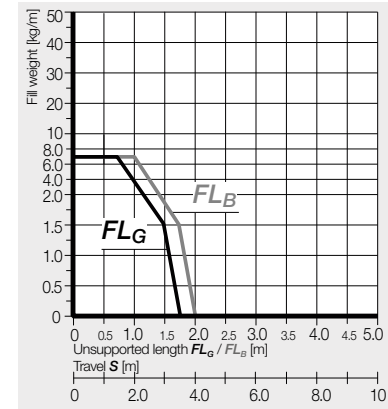

	055 ¹⁾	063 ¹⁾	075	100	125	150	175	200	250
R									
H	15 2	168	192	242	292	34 2	392	44 2	542
D	145	153	165	190	215	240	265	290	340
K	265	290	330	410	485	565	645	725	880

The required clearance height: $H_F = H + 40$ mm (with 1.0kg/m fill weight)

1) Radius not available for e-tubes

If a gliding application is required for a long travel, please consult igus®.

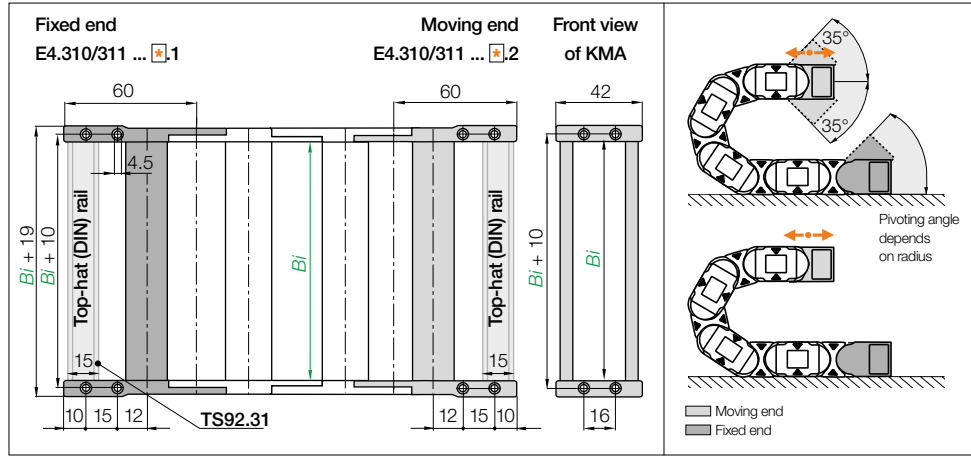

KMA pivoting | Recommended for unsupported and gliding applications
KMA locking | Recommended for vertical hanging and standing applications

Width index	Part No. full set KMA pivoting	Part No. full set KMA locking	Bi [mm]	Width index	Part No. full set KMA pivoting	Part No. full set KMA locking	Bi [mm]
040.	E4.310.040.12.C	E4.311.040.12.C	40	125.	E4.310.125.12.C	E4.311.125.12.C	125
050.	E4.310.050.12.C	E4.311.050.12.C	50	137.	E4.310.137.12.C*	E4.311.137.12.C*	137
062.	E4.310.062.12.C	E4.311.062.12.C	62	150.	E4.310.150.12.C	E4.311.150.12.C	150
075.	E4.310.075.12.C	E4.311.075.12.C	75	162.	E4.310.162.12.C	E4.311.162.12.C	162
087.	E4.310.087.12.C	E4.311.087.12.C	87	175.	E4.310.175.12.C	E4.311.175.12.C	175
100.	E4.310.100.12.C	E4.311.100.12.C	100	187.	E4.310.187.12.C*	E4.311.187.12.C*	187
112.	E4.310.112.12.C	E4.311.112.12.C	112	200.	E4.310.200.12.C*	E4.311.200.12.C*	200

(KMA = polymer metal mounting bracket) For the TS92.31 top-hat (DIN) rail option please add index .C

*Width available upon request. Delivery time upon request. **Note:** If a gliding application is required for a long travel, please consult igus®.

Strain relief elements with tiewrap teeth

- Stepped strain relief element outside of the e-chain® cross section
- For e-chains® and e-tubes
- Easy to retrofit
- Simple installation into top hat (DIN) rail 15 (TS92.31)

Part No. CFV.31.N15 - more information ▶ From page 1428

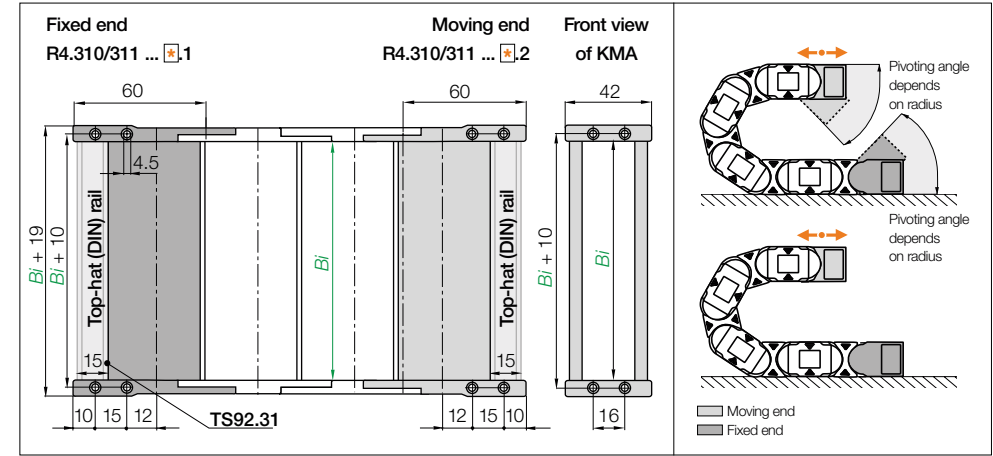

KMA pivoting | Recommended for unsupported and gliding applications
KMA locking | Recommended for vertical hanging and standing applications

Width index	Part No. full set KMA pivoting	Part No. full set KMA locking	Bi [mm]	Width index	Part No. full set KMA pivoting	Part No. full set KMA locking	Bi [mm]
050.	R4.310.050.12.C	R4.311.050.12.C	050	150.	R4.310.150.12.C*	R4.311.150.12.C*	150
075.	R4.310.075.12.C	R4.311.075.12.C	075	175.	R4.310.175.12.C*	R4.311.175.12.C*	175
100.	R4.310.100.12.C	R4.311.100.12.C	100	200.	R4.310.200.12.C*	R4.311.200.12.C*	200
125.	R4.310.125.12.C*	R4.311.125.12.C*	125				

(KMA = polymer metal mounting bracket) For the TS92.31 top-hat (DIN) rail option please add index .C

*Width available upon request. Delivery time upon request. **Note:** If a gliding application is required for a long travel, please consult igus®.

Note: The e-chains® may end with either an inner or an outer side link. An outer side link should always be the first e-chain® link at the moving end. Please specify the index 1 (for odd) or 2 (for even) depending on an even or odd number of links required.

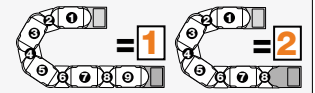

Possible orientations for KMA mounting brackets. For mounting brackets pre-fitted **without C-profile**, please attach index .A. For types pre-fitted **with C-profile**, please attach index .A1, .A2, .A3 or .A4.

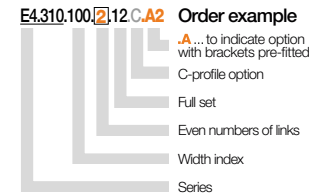

Strain relief e.g. clamps, tiewrap plates, nuggets and clips are available from stock. The complete chainfix range with ordering options ▶ From page 1392

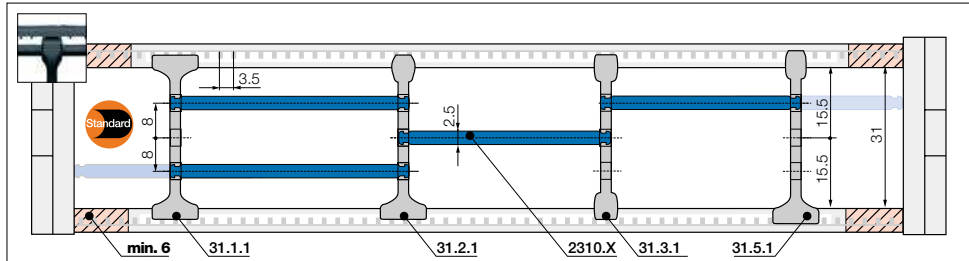

Note: Please be aware of the minimum lateral gap to the side links! **e-tube: 6mm** | **e-chain®: 6mm**
As standard separators are fitted every 2nd e-chain® link!

Standard separator, wide base

unassembled	31.1
assembled	31.1.1

Standard - for any application
Separator with a wide base for maximum holding force.

Separator, narrow top

unassembled	31.2
assembled	31.2.1

For even faster installation
Wide on one side for high holding force, narrow on opposite side for easy cable fitting.

Separator, narrow

unassembled	31.3
assembled	31.3.1

For small cables
Separator with a narrow base for a large number of small cables side by side. Saves space.

Notch separator for notched crossbar

unassembled	31.5
assembled	315.1

Locks securely in preset increments
Notch separator for exact positioning. Recommended for side-mounted applications.

Shelf, lockable

unassembled	2300.X
assembled	2310.X

Horizontal separation
Full-width shelf locks securely into separators at both ends, giving a fixed width. Can be used as full-width or partial shelf.

Shelves
Width = X (mm)

X [mm]	unassembled	assembled	X [mm]	unassembled	assembled	X [mm]	unassembled	assembled
015	2300.015	2310.015	060	2300.060	2310.060	087	2300.87	2310.087
025	2300.025	2310.025	062	2300.062	2310.062	090	2300.90	2310.090
030	2300.030	2310.030	065	2300.065	2310.065	100	2300.100	2310.100
038	2300.038	2310.038	070	2300.070	2310.070	103	2300.103	2310.103
040	2300.040	2310.040	075	2300.075	2310.075	110	2300.110	2310.110
050	2300.050	2310.050	077	2300.077	2310.077	120	2300.120	2310.120
057	2300.057	2310.057	080	2300.080	2310.080	125	2300.125	2310.125

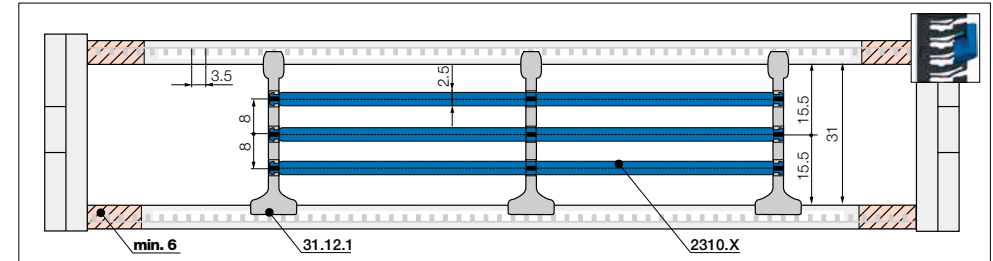

Note: Please be aware of the minimum lateral gap to the side links! **e-tube: 6mm** | **e-chain®: 6mm**
As standard separators are fitted every 2nd e-chain® link!

Lean separator¹⁾

unassembled	31.12
assembled	31.12.1

Lean separators¹⁾
For quick fitting of shelves in several layers.
1) Note: Please combine maximum 4 lean separators with one shelf. Not suitable for side-mounted e-chains!

With the lean separator you can quickly insert several layers of cables into the e-chain® and reduce the installation time by up to 50%²⁾.

²⁾ Lean interior separation vs. Standard separator - measured on a 4m long e-chain® fitted with 12 cables in the igus® readychain® factory



Separator with integrated strain relief teeth

- Can be integrated into the mounting bracket or placed at any point
 - Combines strain relief and interior separation, for restricted space conditions
 - Strain relief separator is easy to assemble without any screws
- Part No. 31.Z - more information ▶ From page 1424**



Aluminium support tray

- Corrosion-resistant and seawater-resistant aluminium rails with adjustable width
 - Noise-reducing glide strip integrated as standard
 - Easy installation and connection of the e-tube
 - Open design - dirt and debris fall through
- More information ▶ From page 1362**



Light design, high dynamics, cost-effective



e-chains® | E4.38L | Crossbars every link (openable along inner and outer radius, from both sides)
e-tubes | R4.38L | Fully enclosed (lids openable along inner and outer radius, from both sides)

Part No.	Part No.	Bi	Ba	E4.38L	R4.38L	Part No.	Part No.	Bi	Ba	E4.38L	R4.38L
e-chains®	e-tubes	[mm]	[mm]	[kg/m]	[kg/m]	e-chains®	e-tubes	[mm]	[mm]	[kg/m]	[kg/m]
E4.38L.050.R.0	R4.38L.050.R.0	50	66	≈ 1.13	≈ 1.20	E4.38L.225.R.0	-	225	241	≈ 1.97	-
E4.38L.062.R.0	-	62	78	≈ 1.19	-	E4.38L.237.R.0	-	237	253	≈ 2.05	-
E4.38L.075.R.0	R4.38L.075.R.0	75	91	≈ 1.26	≈ 1.38	E4.38L.250.R.0	R4.38L.250.R.0	250	266	≈ 2.11	≈ 2.65
E4.38L.087.R.0	-	87	103	≈ 1.30	-	E4.38L.262.R.0	-	262	278	≈ 2.15	-
E4.38L.100.R.0	R4.38L.100.R.0	100	116	≈ 1.37	≈ 1.60	E4.38L.275.R.0**	-	275	291	≈ 2.22	-
E4.38L.105.R.0	-	105	121	≈ 1.39	-	E4.38L.287.R.0**	-	287	303	≈ 2.30	-
E4.38L.112.R.0	-	112	128	≈ 1.44	-	E4.38L.300.R.0	R4.38L.300.R.0**	300	316	≈ 2.36	≈ 3.00
E4.38L.125.R.0	R4.38L.125.R.0	125	141	≈ 1.50	≈ 1.75	E4.38L.312.R.0**	-	312	328	≈ 2.40	-
E4.38L.137.R.0	-	137	153	≈ 1.55	-	E4.38L.325.R.0**	-	325	341	≈ 2.47	-
E4.38L.150.R.0	R4.38L.150.R.0	150	166	≈ 1.65	≈ 1.92	E4.38L.337.R.0**	-	337	353	≈ 2.55	-
E4.38L.162.R.0	-	162	178	≈ 1.69	-	E4.38L.350.R.0**	-	350	366	≈ 2.57	-
E4.38L.175.R.0	R4.38L.175.R.0	175	191	≈ 1.74	≈ 2.10	E4.38L.362.R.0**	-	362	378	≈ 2.60	-
E4.38L.187.R.0	-	187	203	≈ 1.80	-	E4.38L.375.R.0**	-	375	391	≈ 2.65	-
E4.38L.200.R.0	R4.38L.200.R.0	200	216	≈ 1.86	≈ 2.29	E4.38L.387.R.0**	-	387	403	≈ 2.76	-
E4.38L.212.R.0	-	212	228	≈ 1.90	-	E4.38L.400.R.0**	-	400	416	≈ 2.83	-

**Width available upon request. Delivery time upon request.

*Radius available upon request. Please consult igus® for delivery time. 1) Radius not available for e-tubes

Available bend radii

R [mm] | 063¹⁾ | 075¹⁾ | 100¹⁾ | 125 | 150 | 175 | 200 | 250 | 300 | 350*

Complete Part No. with required radius (R). Example:

E4.38L.100.150.0 = crossbars every link / R4.38L.100.150.0 = fully enclosed

Unsupported applications | Short travels

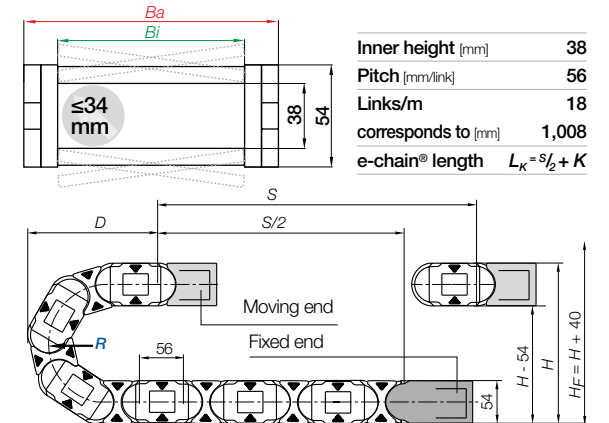
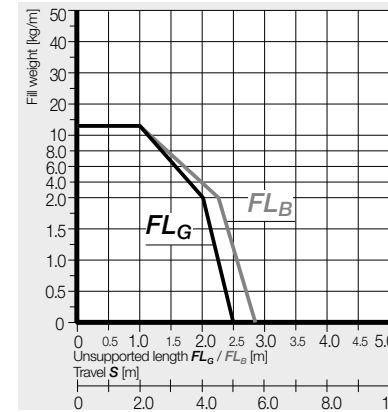

R	063 ¹⁾	075 ¹⁾	100 ¹⁾	125	150	175	200	250	300	350*
H	180	204	254	304	354	404	454	554	654	754
D	174	186	211	236	261	286	311	361	411	461
K	310	350	430	505	585	665	745	900	1,055	1,215

The required clearance height: $H_F = H + 40\text{mm}$ (with 2.0kg/m fill weight)

*Radius available upon request. Please consult igus® for delivery time. 1) Radius not available for e-tubes

Gliding applications | For travel lengths from 10m to max. 80m

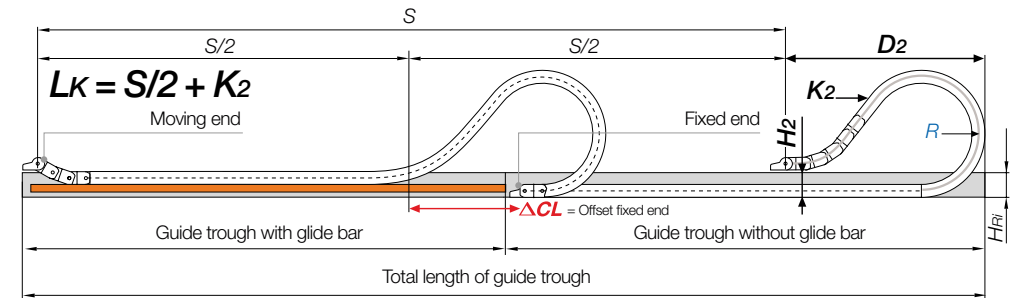

Note: We recommend the project planning of such a system to be carried out by igus®.

In case of travels between 5 and 10m we recommend an e-chain® with a longer unsupported length.

R	063 ¹⁾	075 ¹⁾	100 ¹⁾	125	150	175	200	250 ²⁾	300 ²⁾	350 ²⁾
H ₂	180	204	96	96	96	96	96	-	-	-
D ₂	174	186	370	470	500	655	770	-	-	-
K ₂	310	350	616	784	896	1,120	1,288	-	-	-
ΔCL	-	-	160	210	240	370	460	-	-	-

1) Radius not available for e-tubes 2) Radius not suitable for long travel applications. Please consult igus®.

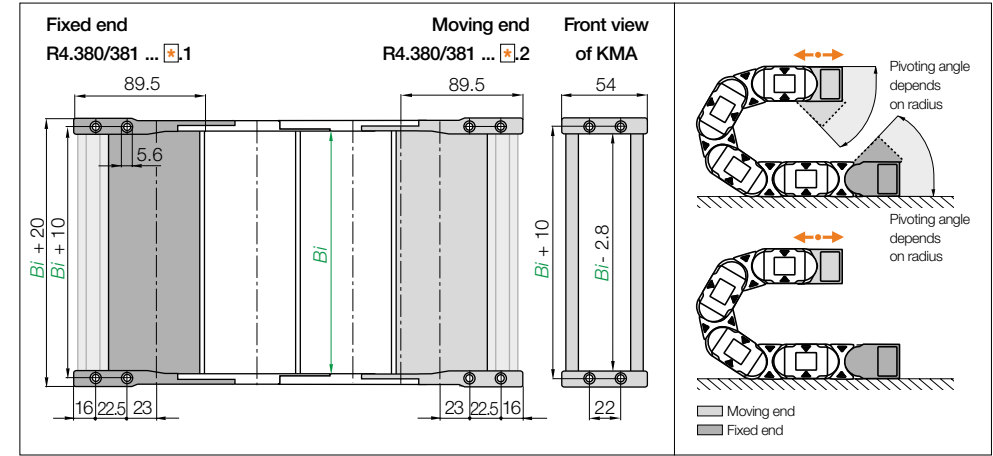
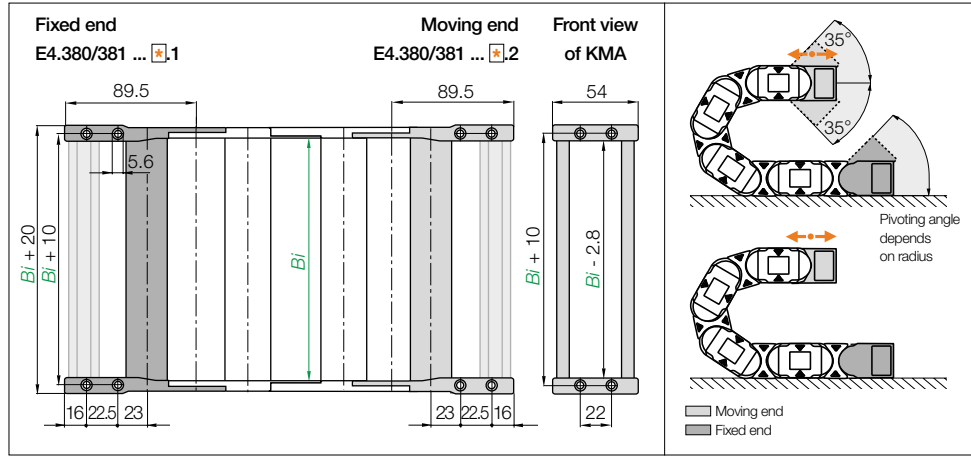

KMA pivoting | Recommended for unsupported and gliding applications
KMA locking | Recommended for vertical hanging and standing applications

Width index	Part No. full set KMA pivoting	Part No. full set KMA locking	Bi [mm]	Width index	Part No. full set KMA pivoting	Part No. full set KMA locking	Bi [mm]
050.	E4.380.050.12.C	E4.381.050.12.C	50	225.	E4.380.225.12.C	E4.381.225.12.C	225
062.	E4.380.062.12.C	E4.381.062.12.C	62	237.	E4.380.237.12.C	E4.381.237.12.C	237
075.	E4.380.075.12.C	E4.381.075.12.C	75	250.	E4.380.250.12.C	E4.381.250.12.C	250
087.	E4.380.087.12.C	E4.381.087.12.C	87	262.	E4.380.262.12.C	E4.381.262.12.C	262
100.	E4.380.100.12.C	E4.381.100.12.C	100	275.	E4.380.275.12.C*	E4.381.275.12.C*	275
105.	E4.380.105.12.C	E4.381.105.12.C	105	287.	E4.380.287.12.C*	E4.381.287.12.C*	287
112.	E4.380.112.12.C	E4.381.112.12.C	112	300.	E4.380.300.12.C	E4.381.300.12.C	300
125.	E4.380.125.12.C	E4.381.125.12.C	125	312.	E4.380.312.12.C*	E4.381.312.12.C*	312
137.	E4.380.137.12.C	E4.381.137.12.C	137	325.	E4.380.325.12.C*	E4.381.325.12.C*	325
150.	E4.380.150.12.C	E4.381.150.12.C	150	337.	E4.380.337.12.C*	E4.381.337.12.C*	337
162.	E4.380.162.12.C	E4.381.162.12.C	162	350.	E4.380.350.12.C*	E4.381.350.12.C*	350
175.	E4.380.175.12.C	E4.381.175.12.C	175	362.	E4.380.362.12.C*	E4.381.362.12.C*	362
187.	E4.380.187.12.C	E4.381.187.12.C	187	375.	E4.380.375.12.C*	E4.381.375.12.C*	375
200.	E4.380.200.12.C	E4.381.200.12.C	200	387.	E4.380.387.12.C*	E4.381.387.12.C*	387
212.	E4.380.212.12.C	E4.381.212.12.C	212	400.	E4.380.400.12.C*	E4.381.400.12.C*	400

(KMA = polymer metal mounting bracket) For the C-profile option please add index .C

*Width available upon request. Delivery time upon request.

KMA pivoting | Recommended for unsupported and gliding applications
KMA locking | Recommended for vertical hanging and standing applications

Width index	Part No. full set KMA pivoting	Part No. full set KMA locking	Bi [mm]	Width index	Part No. full set KMA pivoting	Part No. full set KMA locking	Bi [mm]
050.	R4.380.050.12.C	R4.381.050.12.C	050	175.	R4.380.175.12.C	R4.381.175.12.C	175
075.	R4.380.075.12.C	R4.381.075.12.C	075	200.	R4.380.200.12.C	R4.381.200.12.C	200
100.	R4.380.100.12.C	R4.381.100.12.C	100	250.	R4.380.250.12.C	R4.381.250.12.C	250
125.	R4.380.125.12.C	R4.381.125.12.C	125	300.	R4.380.300.12.C*	R4.381.300.12.C*	300
150.	R4.380.150.12.C	R4.381.150.12.C	150				

(KMA = polymer metal mounting bracket) For the C-profile option please add index .C

*Width available upon request. Delivery time upon request.

Note: The e-chains® may end with either an inner or an outer side link. An outer side link should always be the first e-chain® link at the moving end. Please specify the index 1 (for odd) or 2 (for even) depending on an even or odd number of links required.

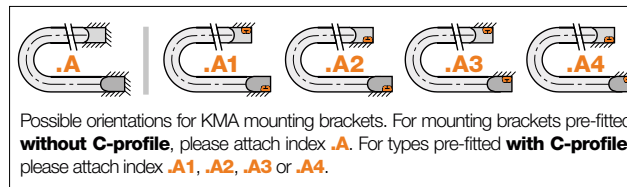
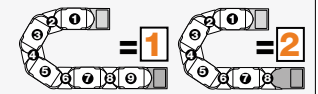

E4.380.100.2.12.C.A2 Order example

- .A... to indicate option with brackets pre-fitted
- C-profile option
- Full set
- Even numbers of links
- Width index
- Series

Strain relief e.g. clamps, tiewrap plates, nuggets and clips are available from stock. The complete chainfix range with ordering options ► From page 1392

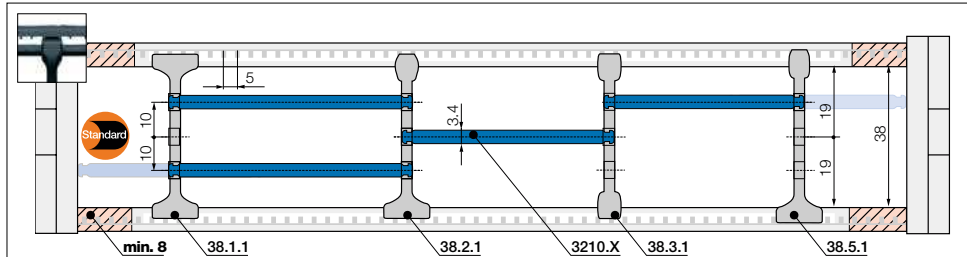

Note: Please be aware of the minimum lateral gap to the side links! **e-tube: 8mm** | **e-chain®: 8mm**
As standard separators are fitted every 2nd e-chain® link!

Standard separator, wide base

unassembled **38.1**
assembled **38.1.1**

Standard - for any application
Separator with a wide base for maximum holding force.

Separator, narrow top

unassembled **38.2**
assembled **38.2.1**

For even faster installation
Wide on one side for high holding force, narrow on opposite side for easy cable fitting.

Separator, narrow

unassembled **38.3**
assembled **38.3.1**

For small cables
Separator with a narrow base for a large number of small cables side by side. Saves space.

Notch separator for notched crossbar

unassembled **38.5**
assembled **38.5.1**

Locks securely in preset increments
Notch separator for exact positioning. Recommended for side-mounted applications.

Shelf, lockable

unassembled **3200.X**
assembled **3210.X**

Horizontal separation
Full-width shelf locks securely into separators at both ends, giving a fixed width. Can be used as full-width or partial shelf.

Shelves Width = X [mm]	X [mm]		X [mm]		X [mm]		X [mm]	
	unassembled	assembled	unassembled	assembled	unassembled	assembled	unassembled	assembled
050	3200.050	3210.050	125	3200.125	3210.125	225	3200.225	3210.225
075	3200.075	3210.075	150	3200.150	3210.150	250	3200.250	3210.250
100	3200.100	3210.100	175	3200.175	3210.175			
115	3200.115	3210.115	200	3200.200	3210.200			

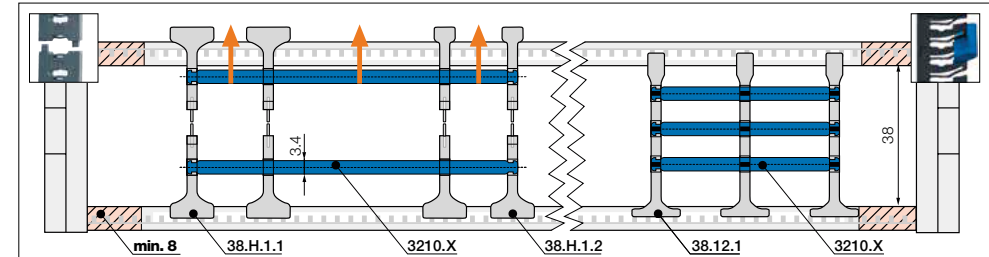

Note: Please be aware of the minimum lateral gap to the side links! **e-tube: 8mm** | **e-chain®: 8mm**
As standard separators are fitted every 2nd e-chain® link!

Split separator, wide base/top

unassembled **38.H.1**
assembled **38.H.1.1**

Split separators
In order to fill e-chains® more easily and effectively, these separators can be split in the middle. This allows easier access to middle shelf partitions. Fast assembly and easy retrofit. 2 types available: with wide or narrow top.

Split separator, narrow top

unassembled **38.H.2**
assembled **38.H.2.1**

Lean separator¹⁾

unassembled **38.12**
assembled **38.12.1**

Lean separators¹⁾
For quick fitting of shelves in several layers.
1) Note: Please combine maximum 4 lean separators with one shelf. Not suitable for side-mounted e-chains®!

With the lean separator you can quickly insert several layers of cables into the e-chain® and reduce the installation time by up to 50%²⁾.

²⁾ Lean interior separation vs. Standard separator - measured on a 4m long e-chain® fitted with 12 cables in the igus® readychain® factory



Separator with integrated strain relief teeth

- Can be integrated into the mounting bracket or placed at any point
- Combines strain relief and interior separation, for restricted space conditions
- Strain relief separator is easy to assemble without any screws

Part No. 38.Z - more information ▶ From page 1424

e-chain® with openable extender crossbars

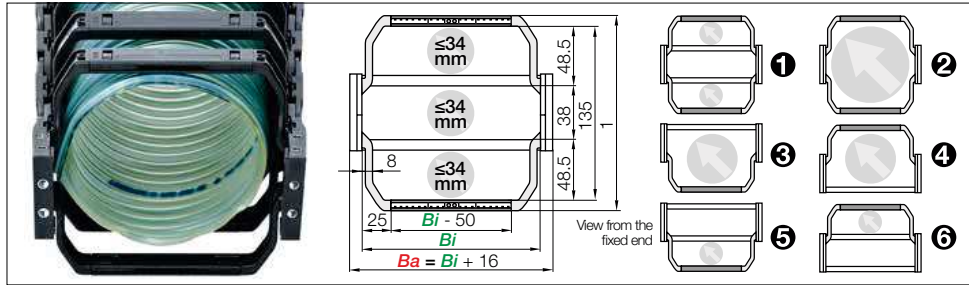

Extender crossbars with flexible width | Safe guiding for large hoses

- For guiding and protecting large hoses
- With mounting for noise dampers
- Cable-friendly design, high crossbar holding force
- The openable extender crossbars can be fitted in different ways and combinations
- Optionally openable along the inner or outer radius

Versions	Hose	Part No.
e-chain® with extender crossbar	$\text{Ø} \leq$ [mm]	e-chain® with extender crossbar
1) Extender crossbar and standard crossbar alternating along the inner and outer radius ¹⁾	34	E4.38L.XXXHB48.R.0
2) Extender crossbar on both sides along the inner and outer radius ²⁾	122	E4.38L.XXXB48.R.0
3) Extender crossbar along the outer radius ³⁾	78	E4.38L.XXXBE48.R.0
4) Extender crossbar along the inner radius ²⁾	78	E4.38L.XXXBZ48.R.0
5) Extender crossbar and standard crossbar alternating along the outer radius ³⁾	34	E4.38L.XXXHBE48.R.0
6) Extender crossbar and standard crossbar alternating along inner radius ¹⁾	34	E4.38L.XXXHBZ48.R.0

1) Minimum bend radius: R 125 2) Minimum bend radius: R 150 3) Minimum bend radius: R 063 *Width available upon request. Delivery time upon request

Bi [mm] Available inner widths

| 100 | 105 | 112 | 125 | 137 | 150 | 162 | 175 | 187 | 200 | 212 | 225 | 237 | 250 | 262 | 275* | 287* | 300 | 312* | 325* | 337* | 350* | 362* | 375* | 387* | 400*

Complete Part No. with the width index XXX of Bi and the minimum bend radius (R). Example:

E4.38L.100B48.150.0 = Bi 100 / extender crossbar on both sides along inner and outer radius / bend radius (R) 150



The E4.1L can be fitted with openable extender crossbars, which increase the size of the interior of the e-chain®. Crossbars can be fitted in various ways: from one or both sides, alternating with standard crossbars and or any combination

Aluminium support tray

- Corrosion-resistant and seawater-resistant aluminium rails with adjustable width
 - Noise-reducing glide strip integrated as standard
 - Easy installation and connection of the e-tube
 - Open design - dirt and debris fall through
- More information ► From page 1362



TUB

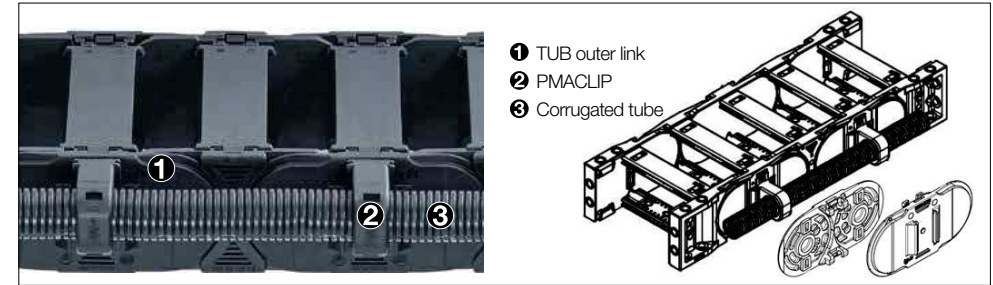

TUB | Safe guidance for corrugated tubes parallel to the e-chain®

- Additional, simple guidance for corrugated tubes on the outside of the e-chain®
- PMACLIP support to be easily clipped on corrugated tubes with nominal widths 07, 10, 12, 17 mm
- Easy access to the corrugated tubes, fast replacement of the hoses
- Reduce assembly time and cost - easy to assemble, without any additional screws or tools
- The part number includes the e-chain® with TUB side sections; the PMACLIP support and the hose are ordered separately

Part No. TUB	Part No. TUB	Part No. TUB	For corrugated tube nominal diameter
Outer link right*	Outer link left*	Outer link at both ends*	Ø [mm]
E4.38L.XXXTUBR.R.0	E4.38L.XXXTUBL.R.0	E4.38L.XXXTUB.R.0	07 / 10 / 12 / 17

*As viewed from the fixed end

Complete Part No. with the width index XXX of Bi and the minimum bend radius (R). Example:

E4.38L.100TUBR.150.0 = with TUB outer sections every 2nd right hand link

Product range | PMACLIP | Support, one-piece, with safety clip

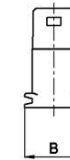
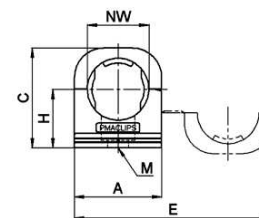

PMACLIP support - one-piece construction with safety clip, suitable for corrugated tubes

Part No.	NW	A	B	C	H	E	M
PMACLIP	Ø [mm]	mm	mm	mm	mm	mm	mm
I-BFH-07-0	07	17.0	20.0	21.5	13.5	40.5	M4
I-BFH-10-0	10	20.5	20.0	24.5	15.5	47.5	M5
I-BFH-12-0	12	24.0	20.0	27.0	16.5	54.5	M5
I-BFH-17-0	17	30.0	20.0	34.0	20.0	68.0	M6



e-chains® | E4.48L | Crossbars every link (openable along inner and outer radius, from both sides)
e-tubes | R4.48L | Fully enclosed (lids openable along inner and outer radius, from both sides)

Part No.	Part No.	Bi	Ba	E4.48L	R4.48L	Part No.	Part No.	Bi	Ba	E4.48L	R4.48L
e-chains®	e-tubes	[mm]	[mm]	[kg/m]	[kg/m]	e-chains®	e-tubes	[mm]	[mm]	[kg/m]	[kg/m]
E4.48L.050.R.0	R4.48L.050.R.0	50	70	≈ 1.53	≈ 1.64	E4.48L.225.R.0	R4.48L.225.R.0	225	245	≈ 2.24	≈ 2.97
E4.48L.062.R.0	R4.48L.062.R.0	62	82	≈ 1.58	≈ 1.69	E4.48L.237.R.0	-	237	257	≈ 2.30	-
E4.48L.075.R.0	R4.48L.075.R.0	75	95	≈ 1.64	≈ 1.82	E4.48L.250.R.0	R4.48L.250.R.0	250	270	≈ 2.35	≈ 3.08
E4.48L.087.R.0	R4.48L.087.R.0**	87	107	≈ 1.67	≈ 1.91	E4.48L.262.R.0	-	262	282	≈ 2.39	-
E4.48L.100.R.0	R4.48L.100.R.0	100	120	≈ 1.73	≈ 2.01	E4.48L.275.R.0**	-	275	295	≈ 2.45	-
E4.48L.105.R.0	-	105	125	≈ 1.74	-	E4.48L.287.R.0**	-	287	307	≈ 2.51	-
E4.48L.112.R.0	R4.48L.112.R.0	112	132	≈ 1.79	≈ 2.15	E4.48L.300.R.0	R4.48L.300.R.0**	300	320	≈ 2.56	≈ 3.42
E4.48L.125.R.0	R4.48L.125.R.0	125	145	≈ 1.84	≈ 2.18	E4.48L.312.R.0**	-	312	332	≈ 2.60	-
E4.48L.137.R.0	-	137	157	≈ 1.88	-	E4.48L.325.R.0**	-	325	345	≈ 2.66	-
E4.48L.150.R.0	R4.48L.150.R.0	150	170	≈ 1.97	≈ 2.36	E4.48L.337.R.0**	-	337	357	≈ 2.72	-
E4.48L.162.R.0	-	162	182	≈ 2.00	-	E4.48L.350.R.0**	-	350	370	≈ 2.74	-
E4.48L.175.R.0	R4.48L.175.R.0	175	195	≈ 2.04	≈ 2.58	E4.48L.362.R.0**	-	362	382	≈ 2.77	-
E4.48L.187.R.0	-	187	207	≈ 2.09	-	E4.48L.375.R.0**	-	375	395	≈ 2.81	-
E4.48L.200.R.0	R4.48L.200.R.0	200	220	≈ 2.14	≈ 2.70	E4.48L.387.R.0**	-	387	407	≈ 2.90	-
E4.48L.212.R.0	-	212	232	≈ 2.18	-	E4.48L.400.R.0**	-	400	420	≈ 2.96	-

**Width available upon request. Delivery time upon request.

1) Radius not available for e-tubes

Available bend radii

R [mm] | 075¹⁾ | 100¹⁾ | 125 | 150 | 175 | 200 | 250 | 300 | 350 |

Complete Part No. with required radius (R). Example:

E4.48L.175.150.0 = crossbars every link / R4.48L.175.150.0 = fully enclosed

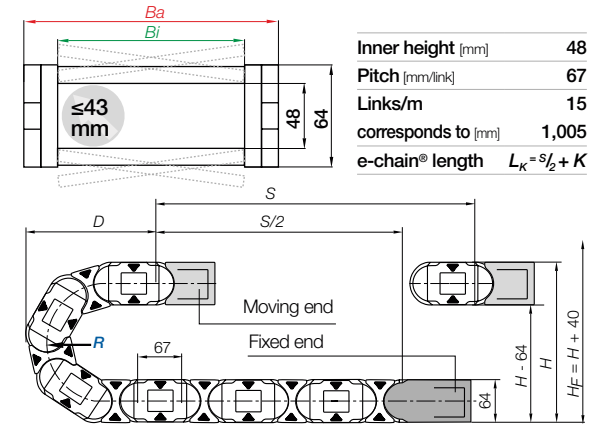
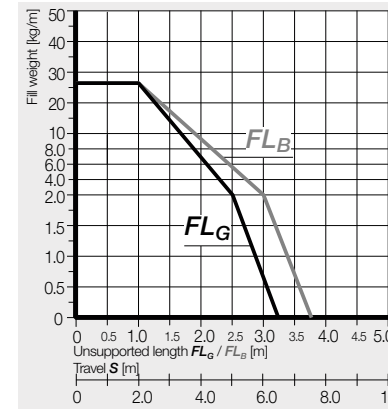

	075 ¹⁾	100 ¹⁾	125	150	175	200	250	300	350
R	075 ¹⁾	100 ¹⁾	125	150	175	200	250	300	350
H	214	264	314	364	414	464	564	664	764
D	208	233	258	283	308	333	383	433	483
K	370	450	530	610	685	765	920	1,080	1,235

The required clearance height: $H_F = H + 40\text{mm}$ (with 2.5kg/m fill weight)

1) Radius not available for e-tubes

Gliding applications | For travel lengths from 10m to max. 100m

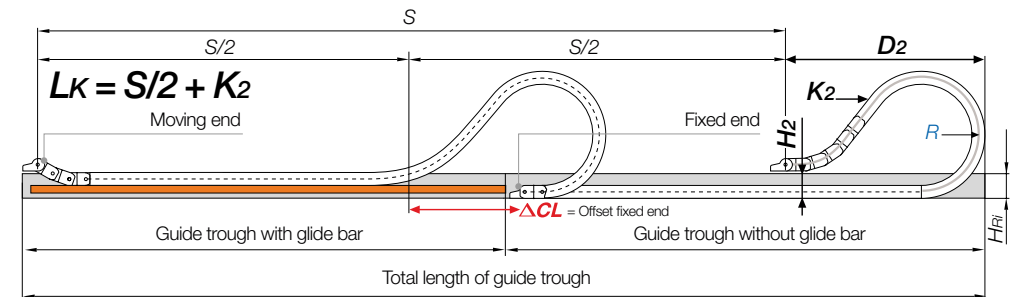

Note: We recommend the project planning of such a system to be carried out by igus®.

In case of travels between 5 and 10m we recommend an e-chain® with a longer unsupported length.

	075 ¹⁾	100 ¹⁾	125	150	175	200	250	300 ²⁾	350 ²⁾
H ₂	214	264	106	106	106	106	106	-	-
D ₂	208	233	475	570	670	780	1,030	-	-
K ₂	370	450	804	938	1,139	1,340	1,675	-	-
ΔCL	-	-	230	300	380	460	660	-	-

1) Radius not available for e-tubes 2) Radius not suitable for long travel applications. Please consult igus®.

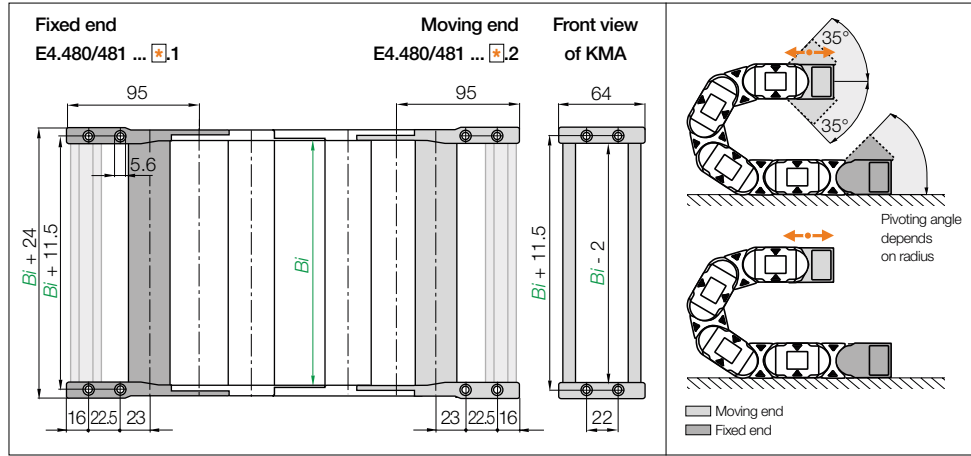

KMA pivoting | Recommended for unsupported and gliding applications
KMA locking | Recommended for vertical hanging and standing applications

Width index	Part No. full set KMA pivoting	Part No. full set KMA locking	Bi [mm]	Width index	Part No. full set KMA pivoting	Part No. full set KMA locking	Bi [mm]
050.	E4.480.050.A12.C	E4.481.050.A12.C	50	225.	E4.480.225.A12.C	E4.481.225.A12.C	225
062.	E4.480.062.A12.C	E4.481.062.A12.C	62	237.	E4.480.237.A12.C	E4.481.237.A12.C	237
075.	E4.480.075.A12.C	E4.481.075.A12.C	75	250.	E4.480.250.A12.C	E4.481.250.A12.C	250
087.	E4.480.087.A12.C	E4.481.087.A12.C	87	262.	E4.480.262.A12.C	E4.481.262.A12.C	262
100.	E4.480.100.A12.C	E4.481.100.A12.C	100	275.	E4.480.275.A12.C*	E4.481.275.A12.C*	275
105.	E4.480.105.A12.C	E4.481.105.A12.C	105	287.	E4.480.287.A12.C*	E4.481.287.A12.C*	287
112.	E4.480.112.A12.C	E4.481.112.A12.C	112	300.	E4.480.300.A12.C	E4.481.300.A12.C	300
125.	E4.480.125.A12.C	E4.481.125.A12.C	125	312.	E4.480.312.A12.C*	E4.481.312.A12.C*	312
137.	E4.480.137.A12.C	E4.481.137.A12.C	137	325.	E4.480.325.A12.C*	E4.481.325.A12.C*	325
150.	E4.480.150.A12.C	E4.481.150.A12.C	150	337.	E4.480.337.A12.C*	E4.481.337.A12.C*	337
162.	E4.480.162.A12.C	E4.481.162.A12.C	162	350.	E4.480.350.A12.C*	E4.481.350.A12.C*	350
175.	E4.480.175.A12.C	E4.481.175.A12.C	175	362.	E4.480.362.A12.C*	E4.481.362.A12.C*	362
187.	E4.480.187.A12.C	E4.481.187.A12.C	187	375.	E4.480.375.A12.C*	E4.481.375.A12.C*	375
200.	E4.480.200.A12.C	E4.481.200.A12.C	200	387.	E4.480.387.A12.C*	E4.481.387.A12.C*	387
212.	E4.480.212.A12.C	E4.481.212.A12.C	212	400.	E4.480.400.A12.C*	E4.481.400.A12.C*	400

(KMA = polymer metal mounting bracket) For the C-profile option please add index .C

*Width available upon request. Delivery time upon request.

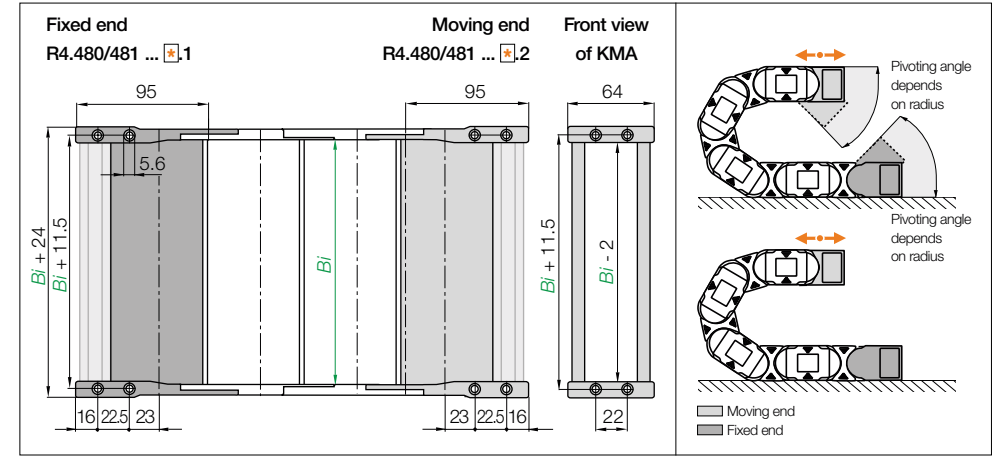

KMA pivoting | Recommended for unsupported and gliding applications
KMA locking | Recommended for vertical hanging and standing applications

Width index	Part No. full set KMA pivoting	Part No. full set KMA locking	Bi [mm]	Width index	Part No. full set KMA pivoting	Part No. full set KMA locking	Bi [mm]
050.	R4.480.050.A12.C	R4.481.050.A12.C	050	150.	R4.480.150.A12.C	R4.481.150.A12.C	150
062.	R4.480.062.A12.C	R4.481.062.A12.C	062	175.	R4.480.175.A12.C	R4.481.175.A12.C	175
075.	R4.480.075.A12.C	R4.481.075.A12.C	075	200.	R4.480.200.A12.C	R4.481.200.A12.C	225
087.	R4.480.087.A12.C*	R4.481.087.A12.C*	087	225.	R4.480.225.A12.C*	R4.481.225.A12.C*	200
100.	R4.480.100.A12.C	R4.481.100.A12.C	100	250.	R4.480.250.A12.C	R4.481.250.A12.C	250
112.	R4.480.112.A12.C	R4.481.112.A12.C	112	300.	R4.480.300.A12.C*	R4.481.300.A12.C*	300
125.	R4.480.125.A12.C	R4.481.125.A12.C	125				

(KMA = polymer metal mounting bracket) For the C-profile option please add index .C

*Width available upon request. Delivery time upon request.

Note: The e-chains® may end with either an inner or an outer side link. An outer side link should always be the first e-chain® link at the moving end. Please specify the index 1 (for odd) or 2 (for even) depending on an even or odd number of links required.

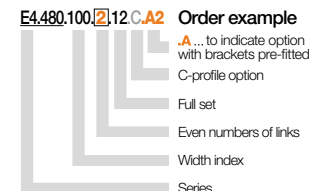
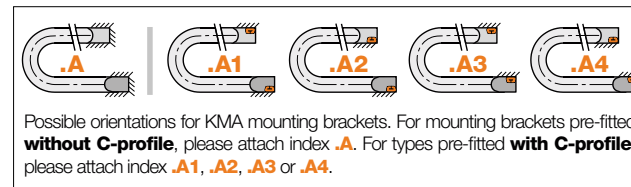
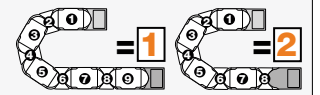

Strain relief e.g. clamps, tiewrap plates, nuggets and clips are available from stock. The complete chainfix range with ordering options ► From page 1392

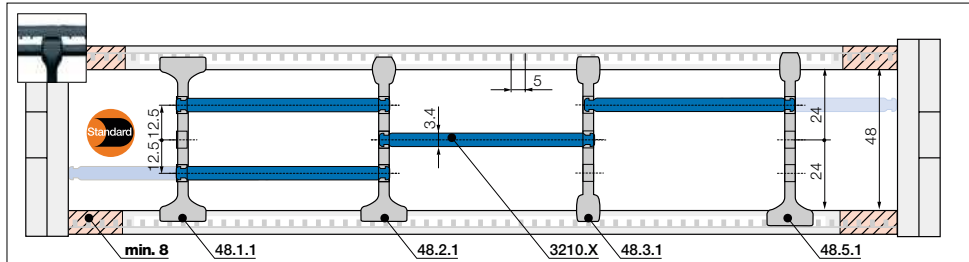

Note: Please be aware of the minimum lateral gap to the side links! **e-tube: 8mm** | **e-chain®: 8mm**
As standard separators are fitted every 2nd e-chain® link!

Standard separator, wide base

unassembled	48.1
assembled	48.1.1

Standard - for any application
Separator with a wide base for maximum holding force.

Separator, narrow top

unassembled	48.2
assembled	48.2.1

For even faster installation
Wide on one side for high holding force, narrow on opposite side for easy cable fitting.

Separator, narrow

unassembled	48.3
assembled	48.3.1

For small cables
Separator with a narrow base for a large number of small cables side by side. Saves space.

Notch separator for notched crossbar

unassembled	48.5
assembled	48.5.1

Locks securely in preset increments
Notch separator for exact positioning. Recommended for side-mounted applications.

Shelf, lockable

unassembled	3200.X
assembled	3210.X

Horizontal separation
Full-width shelf locks securely into separators at both ends, giving a fixed width. Can be used as full-width or partial shelf.

Shelves Width = X [mm]	X [mm]		X [mm]		X [mm]			
	unassembled	assembled	unassembled	assembled	unassembled	assembled		
050	3200.050	3210.050	125	3200.125	3210.125	225	3200.225	3210.225
075	3200.075	3210.075	150	3200.150	3210.150	250	3200.250	3210.250
100	3200.100	3210.100	175	3200.175	3210.175			
115	3200.115	3210.115	200	3200.200	3210.200			

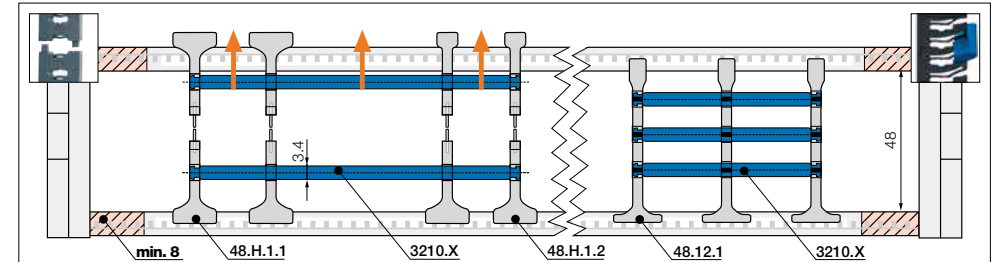

Note: Please be aware of the minimum lateral gap to the side links! **e-tube: 8mm** | **e-chain®: 8mm**
As standard separators are fitted every 2nd e-chain® link!

Split separator, wide base/top

unassembled	48.H.1
assembled	48.H.1.1

Split separators
In order to fill e-chains® more easily and effectively, these separators can be split in the middle. This allows easier access to middle shelf partitions. Fast assembly and easy retrofit. 2 types available: with wide or narrow top.

Split separator, narrow top

unassembled	48.H.2
assembled	48.H.2.1

Lean separator¹⁾

unassembled	48.12
assembled	48.12.1

Lean separators¹⁾
For quick fitting of shelves in several layers.
1) Note: Please combine maximum 4 lean separators with one shelf. Not suitable for side-mounted e-chains®!

With the lean separator you can quickly insert several layers of cables into the e-chain® and reduce the installation time by up to 50%²⁾.

²⁾ Lean interior separation vs. Standard separator - measured on a 4m long e-chain® fitted with 12 cables in the igus® readychain® factory



Separator with integrated strain relief teeth

- Can be integrated into the mounting bracket or placed at any point
- Combines strain relief and interior separation, for restricted space conditions
- Strain relief separator is easy to assemble without any screws

2 versions: Part No. 48.Z / Part No. 48.ZS - more information ▶ Form page 1424

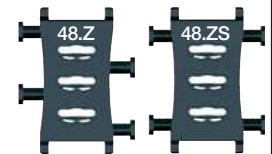

Extension links

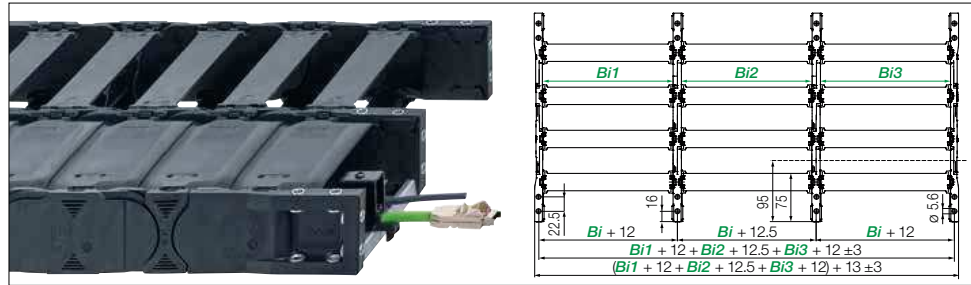

Extension links | For extremely wide e-chains® up to 2.0m with 50% more fill weight

- Extension link e-chains® for 50% higher fill weight extension link up to widths of 2.0m and more
- For heavy fill weights or e-chains® with many heavy cables next to each other
- e-chains® and e-tubes can be combined

Part No.	Part No.	Part No.
Extension link e-chain®	Extension link e-tube	Extension link as an individual part
E4.48L.Bi1/Bi2/Bi3.R.0	R4.48L.Bi1/Bi2/Bi3.R.0	E4.48ML.R.

Complete Part No. with the width index *Bi1/Bi2/Bi3/etc.* and the radius (*R*). Example: E4.48L.175/175/175.150.0

Increase of the fill weight per extension link

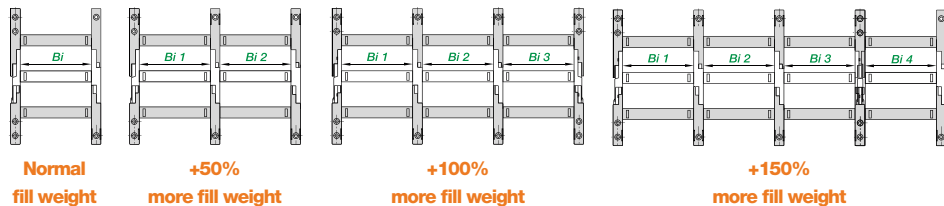

e-chain® with openable extender crossbars

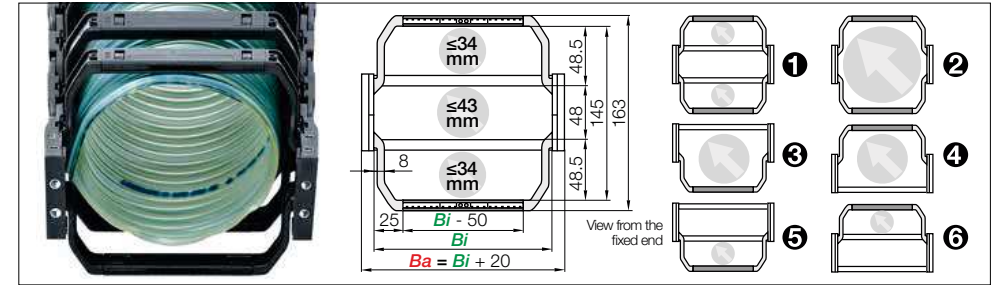

Extender crossbars with flexible width | Safe guiding for large hoses

- For guiding and protecting large hoses
- With mounting for noise dampers
- Cable-friendly design, high crossbar holding force
- The openable extender crossbars can be fitted in different ways and combinations
- Optionally openable along the inner or outer radius

Versions	Hose Ø ≤ [mm]	Part No. e-chain® with extender crossbar
1) Extender crossbar and standard crossbar alternating along the inner and outer radius ¹⁾	34	E4.48L.XXXHB48.R.0
2) Extender crossbar on both sides along the inner and outer radius ²⁾	130	E4.48L.XXXB48.R.0
3) Extender crossbar along the outer radius ³⁾	85	E4.48L.XXXBE48.R.0
4) Extender crossbar along the inner radius ²⁾	85	E4.48L.XXXBZ48.R.0
5) Extender crossbar and standard crossbar alternating along the outer radius ³⁾	34	E4.48L.XXXHBE48.R.0
6) Extender crossbar and standard crossbar alternating along inner radius ¹⁾	34	E4.48L.XXXHBZ48.R.0

1) Minimum bend radius: *R 125* 2) Minimum bend radius: *R 150* 3) Minimum bend radius: *R 075* *Width available upon request. Delivery time upon request

Bi [mm] Available inner widths

| 100 | 105 | 112 | 125 | 137 | 150 | 162 | 175 | 187 | 200 | 212 | 225 | 237 | 250 | 262 | 275* | 287* | 300 | 312* | 325* | 337* | 350* | 362* | 375* | 387* | 400* |

Complete Part No. with the width index *XXX* of *Bi* and the minimum bend radius (*R*). Example:

E4.48L.100B48.150.0 = *Bi 100* / extender crossbar on both sides along inner and outer radius / bend radius (*R*) 150



The E4.1L can be fitted with openable extender crossbars, which increase the size of the interior of the e-chain®. Crossbars can be fitted in various ways: from one or both sides, alternating with standard crossbars and or any combination

TUB

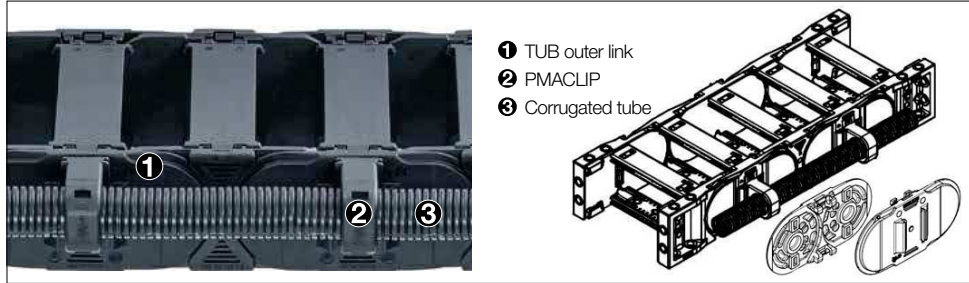

TUB | Safe guidance for corrugated tubes parallel to the e-chain®

- Additional, simple guidance for corrugated tubes on the outside of the e-chain®
- PMACLIP support to be easily clipped on corrugated tubes with nominal widths 7, 10, 12, 17, 23, 29, 36mm
- Easy access to the corrugated tubes, fast replacement of the hoses
- Reduce assembly time and cost - easy to assemble, without any additional screws or tools
- The part number includes the e-chain® with TUB side sections; the PMACLIP support and the hose are ordered separately

Part No. TUB	Part No. TUB	Part No. TUB	For corrugated tube nominal diameter
Outer link right*	Outer link left*	Outer link at both ends*	Ø [mm]
E4.48L.XXXTUBR.R.0	E4.48L.XXXTUBL.R.0	E4.48L.XXXTUB.R.0	07 / 10 / 12 / 17 / 23 / 29 / 36

*As viewed from the fixed end

Complete Part No. with the width index **XXX** of **Bi** and the minimum bend radius (**R**). Example:

E4.48L.100TUBR.150.0 = with TUB outer sections every 2nd right hand link

Product range | PMACLIP | Support, one-piece, with safety clip

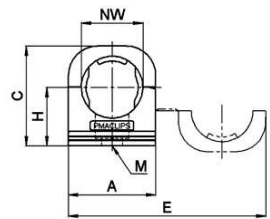

PMACLIP support - one-piece construction with safety clip, suitable for corrugated tubes

Part No.	NW	A	B	C	H	E	M
PMACLIP	Ø [mm]	mm	mm	mm	mm	mm	mm
I-BFH-07-0	07	17.0	20.0	21.5	13.5	40.5	M4
I-BFH-10-0	10	20.5	20.0	24.5	15.5	47.5	M5
I-BFH-12-0	12	24.0	20.0	27.0	16.5	54.5	M5
I-BFH-17-0	17	30.0	20.0	34.0	20.0	68.0	M6
I-BFH-23-0	23	38.5	20.0	42.0	24.0	85.0	M6
I-BFH-29-0	29	45.5	20.0	48.0	27.0	99.0	M6
I-BFH-36-0	36	55.5	20.0	56.0	31.0	119.0	M6

Steel support tray for support of the lower run

- Simple one-piece support trays for the lower run
 - To your requirements and specification
 - 4 options available
- More information ► From page 1356

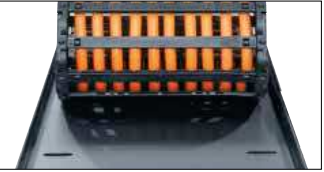

CFU strain relief with innovative honeycomb design

- Fast filling, openable from both sides for assembly in seconds
 - Flexible honeycomb design for increased holding force
 - Tribologically optimised honeycomb design for the best hold
 - Universal use, compact, space-saving design
- More information ► Page 1424



Due to the modular design, the E4.1L system can be adapted to almost any application. As an open version for cable guidance, with extender crossbars for large hoses, or enclosed chip-resistant tube complete with guide trough - just three of many options

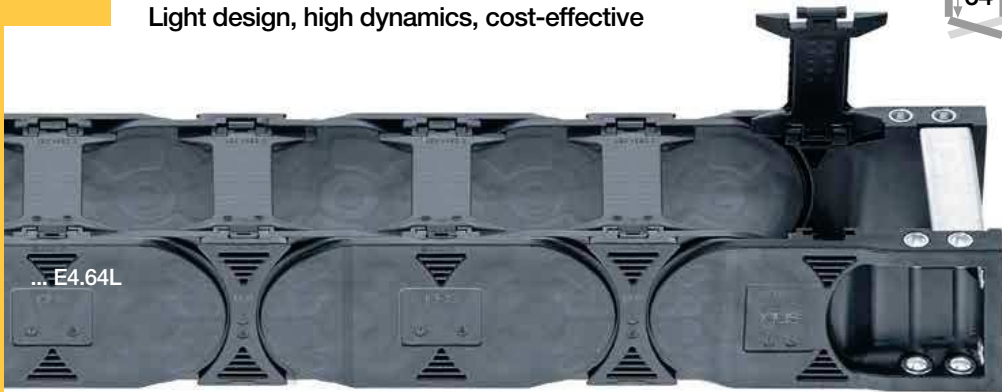

e-chains® | E4.64L | Crossbars every link (openable along inner and outer radius, from both sides)

Part No. e-chains®	Bi [mm]	Ba [mm]	E4.64L [kg/m]	Part No. e-chains®	Bi [mm]	Ba [mm]	E4.64L [kg/m]
E4.64L.050.R.0*	50	76	≈ 2.37	E4.64L.237.R.0*	237	263	≈ 3.12
E4.64L.062.R.0*	62	88	≈ 2.41	E4.64L.250.R.0*	250	276	≈ 3.18
E4.64L.075.R.0	75	101	≈ 2.47	E4.64L.262.R.0*	262	288	≈ 3.22
E4.64L.087.R.0	87	113	≈ 2.54	E4.64L.275.R.0*	275	301	≈ 3.28
E4.64L.100.R.0	100	126	≈ 2.57	E4.64L.287.R.0*	287	313	≈ 3.33
E4.64L.112.R.0	112	138	≈ 2.63	E4.64L.300.R.0	300	326	≈ 3.38
E4.64L.125.R.0	125	151	≈ 2.67	E4.64L.312.R.0*	312	338	≈ 3.43
E4.64L.137.R.0*	137	163	≈ 2.72	E4.64L.325.R.0	325	351	≈ 3.48
E4.64L.150.R.0	150	176	≈ 2.77	E4.64L.337.R.0*	337	363	≈ 3.54
E4.64L.162.R.0*	162	188	≈ 2.83	E4.64L.350.R.0	350	376	≈ 3.58
E4.64L.175.R.0	175	201	≈ 2.87	E4.64L.362.R.0*	362	388	≈ 3.63
E4.64L.187.R.0	187	213	≈ 2.93	E4.64L.375.R.0*	375	401	≈ 3.68
E4.64L.200.R.0	200	226	≈ 2.97	E4.64L.387.R.0*	387	413	≈ 3.73
E4.64L.212.R.0	212	238	≈ 3.03	E4.64L.400.R.0*	400	426	≈ 3.78
E4.64L.225.R.0	225	251	≈ 3.08				

*Width available upon request. Delivery time upon request.

Available bend radii

R [mm] | 100 | 125 | 150 | 175 | 200 | 250 | 300 | 350 | 400 |

Complete Part No. with required radius (R). Example: E4.64L.150.150.0 = crossbars every link

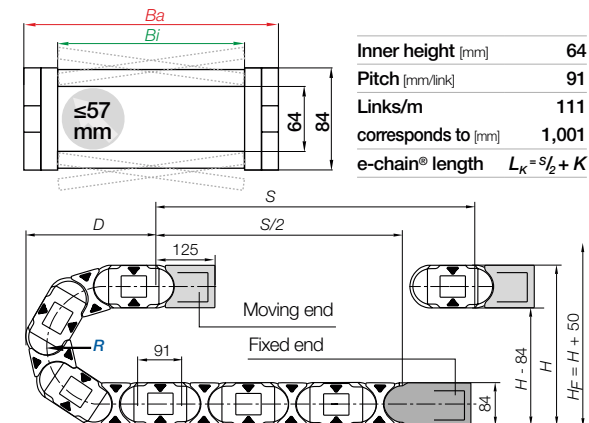
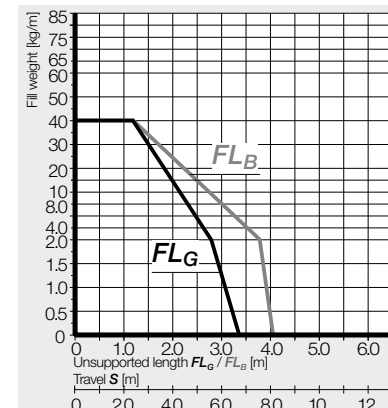

	100	125	150	175	200	250	300	350	400
R	100	125	150	175	200	250	300	350	400
H	284	334	384	434	484	584	684	784	884
D	279	304	329	354	379	429	479	529	579
K	500	575	655	735	815	970	1,125	1,285	1,440

The required clearance height: $H_F = H + 50\text{mm}$ (with 2.0kg/m fill weight)

Gliding applications | For long travels, upon request

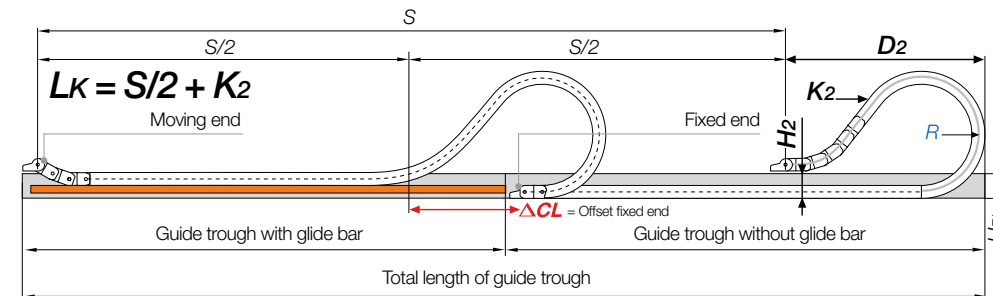

Note: We recommend the project planning of such a system to be carried out by igus®.

In case of travels between 5 and 10m we recommend an e-chain® with a longer unsupported length.

	100	125	150	175	200	250	300	350	400
H ₂	**	180	180	180	180	180	-	-	-
D ₂	**	505	580	705	830	1,080	-	-	-
K ₂	**	819	910	1,183	1,365	1,729	-	-	-
ΔCL	**	**	**	**	**	**	-	-	-

**Values upon request

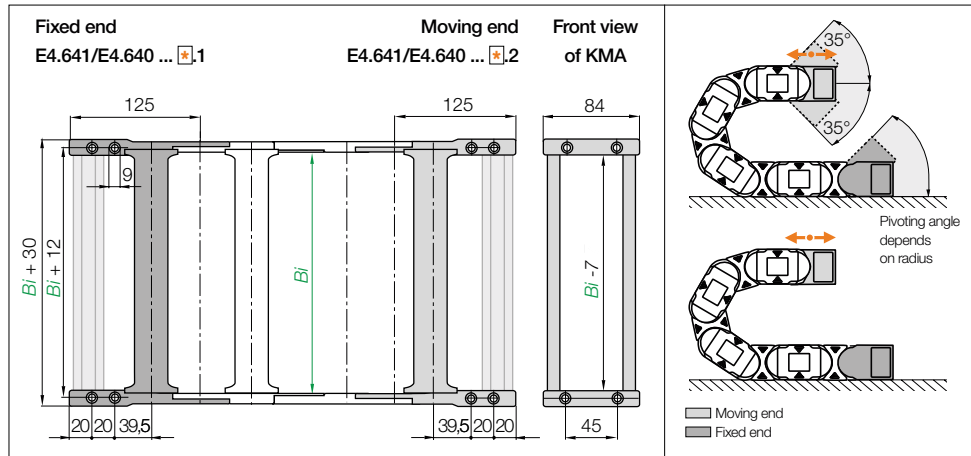

KMA pivoting | Recommended for unsupported and gliding applications
KMA locking | Recommended for vertical hanging and standing applications

Width index	Part No. full set KMA pivoting	Part No. full set KMA locking	Bi [mm]	Width index	Part No. full set KMA pivoting	Part No. full set KMA locking	Bi [mm]
050.	E4.640.050.12.C*	E4.641.050.12.C*	50	237.	E4.640.237.12.C*	E4.641.237.12.C*	237
062.	E4.640.062.12.C*	E4.641.062.12.C*	62	250.	E4.640.250.12.C*	E4.641.250.12.C*	250
075.	E4.640.075.12.C	E4.641.075.12.C	75	262.	E4.640.262.12.C*	E4.641.262.12.C*	262
087.	E4.640.087.12.C	E4.641.087.12.C	87	275.	E4.640.275.12.C*	E4.641.275.12.C*	275
100.	E4.640.100.12.C	E4.641.100.12.C	100	287.	E4.640.287.12.C*	E4.641.287.12.C*	287
112.	E4.640.112.12.C	E4.641.112.12.C	112	300.	E4.640.300.12.C	E4.641.300.12.C	300
125.	E4.640.125.12.C	E4.641.125.12.C	125	312.	E4.640.312.12.C*	E4.641.312.12.C*	312
137.	E4.640.137.12.C*	E4.641.137.12.C*	137	325.	E4.640.325.12.C	E4.641.325.12.C	325
150.	E4.640.150.12.C	E4.641.150.12.C	150	337.	E4.640.337.12.C*	E4.641.337.12.C*	337
162.	E4.640.162.12.C*	E4.641.162.12.C*	162	350.	E4.640.350.12.C	E4.641.350.12.C	350
175.	E4.640.175.12.C	E4.641.175.12.C	175	362.	E4.640.362.12.C*	E4.641.362.12.C*	362
187.	E4.640.187.12.C	E4.641.187.12.C	187	375.	E4.640.375.12.C*	E4.641.375.12.C*	375
200.	E4.640.200.12.C	E4.641.200.12.C	200	387.	E4.640.387.12.C*	E4.641.387.12.C*	387
212.	E4.640.212.12.C	E4.641.212.12.C	212	400.	E4.640.400.12.C*	E4.641.400.12.C*	400
225.	E4.640.225.12.C	E4.641.225.12.C	225				

(KMA = polymer metal mounting bracket) For the C-profile option please add index .C *Width available upon request. Delivery time upon request.

Note: **1** The e-chains® may end with either an inner or an outer side link. An outer side link should always be the first e-chain® link at the moving end. Please specify the index **1** (for odd) or **2** (for even) depending on an even or odd number of links required.

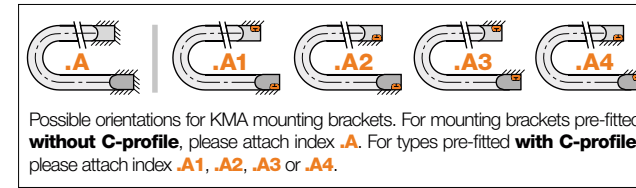
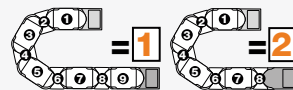

Strain relief e.g. clamps, tiewrap plates, nuggets and clips are available from stock. The complete chainfix range with ordering options ► From page 1392



R4.1L e-tubes to guide motor, encoder and sensor cables on a bending machine

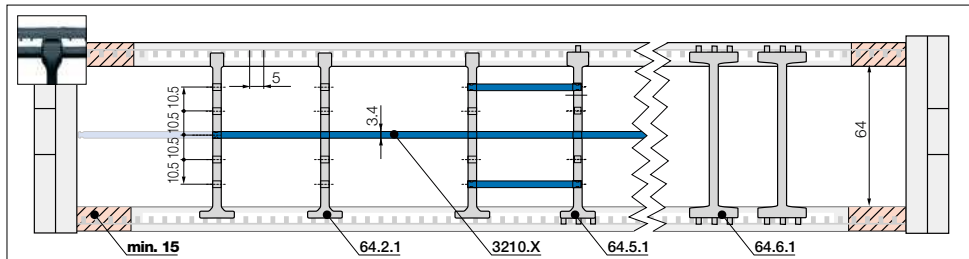

Note: Please be aware of the minimum lateral gap to the side links! **e-chain®: 15mm**
As standard separators are fitted every 2nd e-chain® link!

	4		Separator, narrow top
	3		
	14		unassembled 64.2
			assembled 64.2.1

For even faster installation
Wide on one side for high holding force, narrow on opposite side for easy cable fitting.

	6.8		Notch separator for notched crossbar
	3		
	13		unassembled 64.5
			assembled 64.5.1

Locks securely in preset increments
Notch separator for exact positioning.
Recommended for side-mounted applications.

	X-1		Shelf, lockable
			unassembled 3200.X
			assembled 3210.X

Horizontal separation
Full-width shelf locks securely into separators at both ends, giving a fixed width. Can be used as full-width or partial shelf.

Shelves Width = X (mm)	X (mm)	unassembled	assembled	X (mm)	unassembled	assembled	X (mm)	unassembled	assembled
		050	3200.050	3210.050	125	3200.125	3210.125	225	3200.225
	075	3200.075	3210.075	150	3200.150	3210.150	250	3200.250	3210.250
	100	3200.100	3210.100	175	3200.175	3210.175			
	115	3200.115	3210.115	200	3200.200	3210.200			

More interior separation options

	4		Notch locking separator, lockable for e-chains®
	17		
			unassembled 64.6
			assembled 64.6.1

Notch locking separator for increased holding force
Notch locking separators offer higher crossbar opening forces for high humidity and/or large hydraulic hoses. They can be positioned precisely and then locked in position.

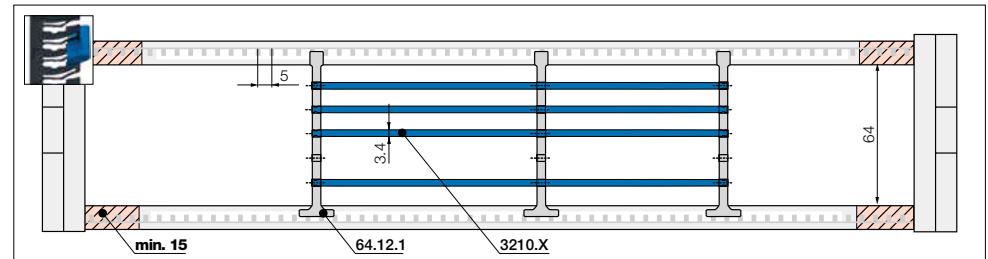

Note: Please be aware of the minimum lateral gap to the side links! **e-tube: 8mm | e-chain®: 8mm**
As standard separators are fitted every 2nd e-chain® link!

	4		Lean separator¹⁾
	3		
	14		unassembled 64.12
			assembled 64.12.1

Lean separators¹⁾
For quick fitting of shelves in several layers.
1) Note: Please combine maximum 4 lean separators with one shelf. Not suitable for side-mounted e-chains®!

With the lean separator you can quickly insert several layers of cables into the e-chain® and reduce the installation time by up to 50%²⁾.

²⁾ Lean interior separation vs. Standard separator - measured on a 4m long e-chain® fitted with 12 cables in the igus® readychain® factory



Low weight combined with high strength for long unsupported lengths: E4.1L

e-chain® with openable extender crossbars

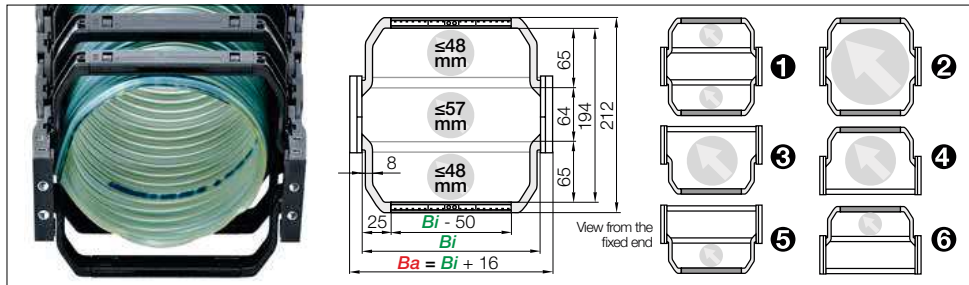

Extender crossbars with flexible width | Safe guiding for large hoses

- For guiding and protecting large hoses
- With mounting for noise dampers
- Cable-friendly design, high crossbar holding force
- The openable extender crossbars can be fitted in different ways and combinations
- Optionally openable along the inner or outer radius

Versions

e-chain® with extender crossbar	Hose Ø ≤ [mm]	Part No.
① Extender crossbar and standard crossbar alternating along the inner and outer radius ¹⁾	48	E4.64L.XXXHB65.R.0
② Extender crossbar on both sides along the inner and outer radius ²⁾	170	E4.64L.XXXB65.R.0
③ Extender crossbar along the outer radius ³⁾	115	E4.64L.XXXBE65.R.0
④ Extender crossbar along the inner radius ²⁾	115	E4.64L.XXXBZ65.R.0
⑤ Extender crossbar and standard crossbar alternating along the outer radius ³⁾	48	E4.64L.XXXHBE65.R.0
⑥ Extender crossbar and standard crossbar alternating along inner radius ¹⁾	48	E4.64L.XXXHBZ65.R.0

1) Minimum bend radius: $R 125$ 2) Minimum bend radius: $R 150$ 3) Minimum bend radius: $R 100$ *Width available upon request. Delivery time upon request

 B_i [mm] Available inner widths

| 100 | 112 | 125 | 137* | 150 | 162* | 175 | 187 | 200 | 212 | 225 | 237* | 250* | 262* | 275* | 287* | 300 | 312* | 325 | 337* | 350 | 362* | 375* | 387* | 400*

Complete Part No. with the width index XXX of B_i and the minimum bend radius (R). Example:

E4.64L.100B65.150.0 = $B_i 100$ / extender crossbar on both sides along inner and outer radius / bend radius (R) 150



The E4.1L can be fitted with openable extender crossbars, which increase the size of the interior of the e-chain®. Crossbars can be fitted in various ways: from one or both sides, alternating with standard crossbars and or any combination

Steel support tray for support of the lower run

- Simple one-piece support trays for the lower run
- To your requirements and specification
- 4 options available

More information ► From page 1356

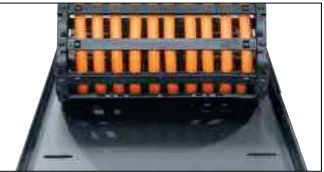

The sharp S with the centrally arranged guided link system - in order to be able to implement the telescoping arm projecting from both sides, two igus® E4.1L series e-chains® were combined together offset by 180 degrees